

— Opmålt af Hedeselskabet, 1992.

- - - - - Regulativ

lodret akse : kote i m skala 1:1 00
 vandret akse : afstand i m skala 1:1 00

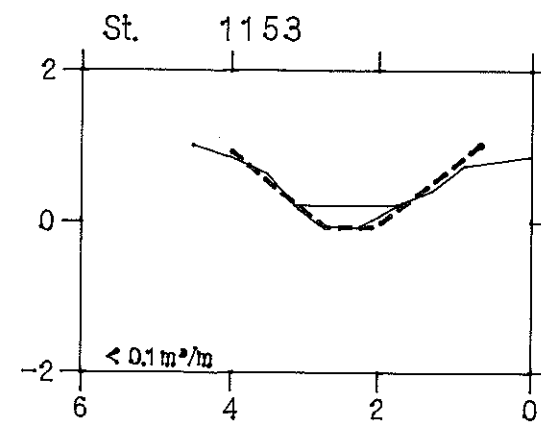
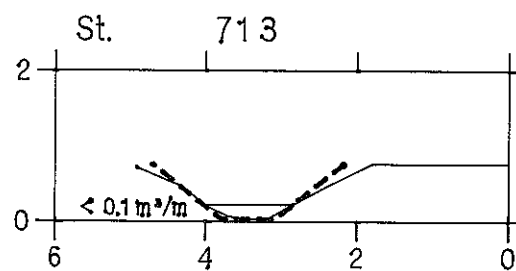
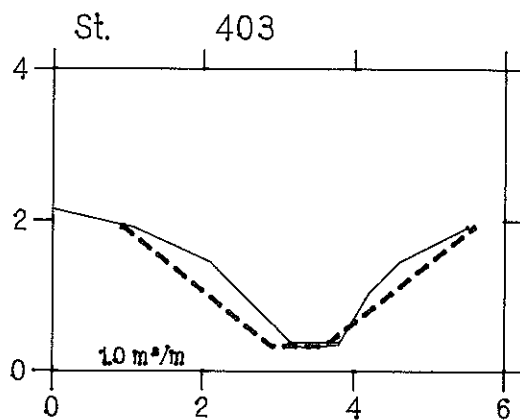
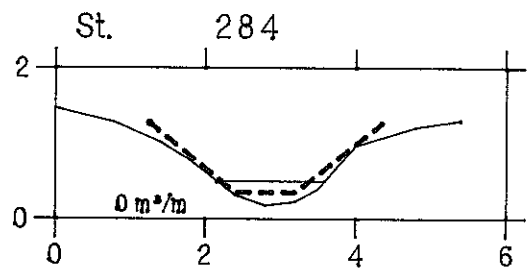
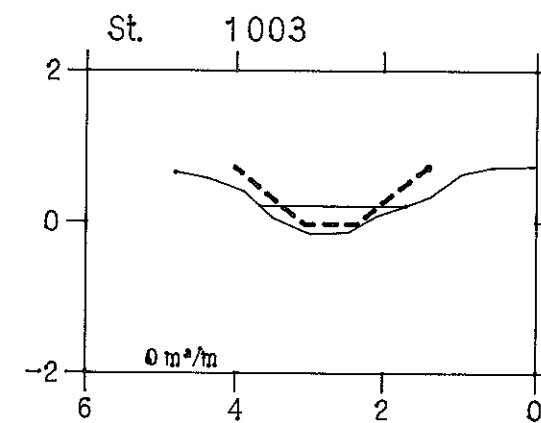
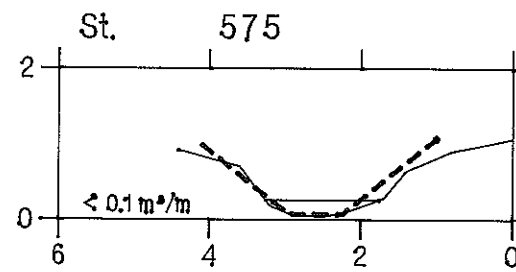
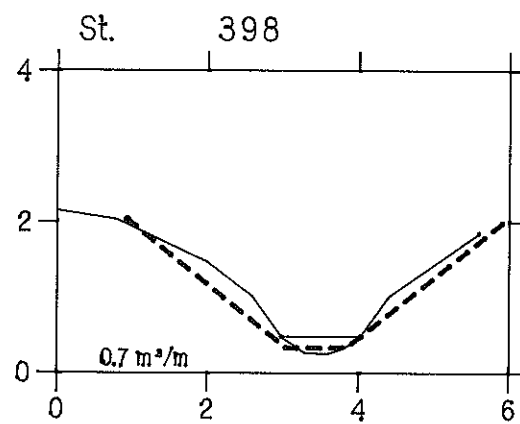
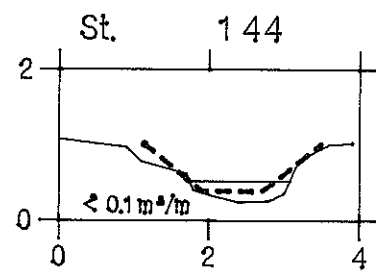
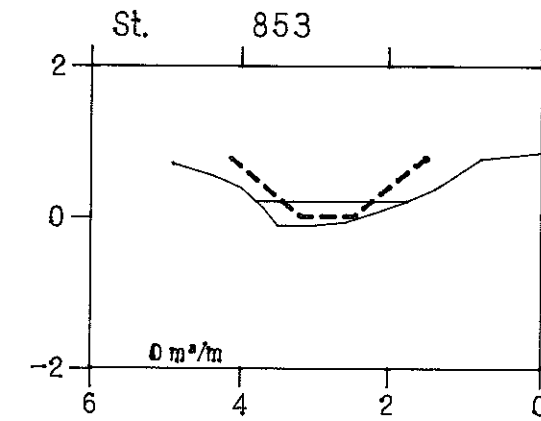
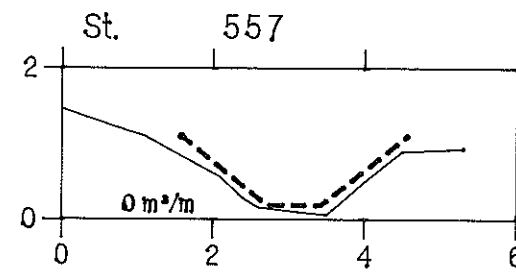
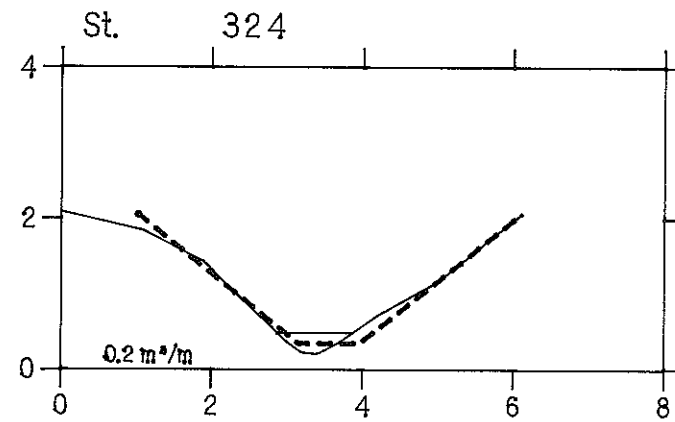
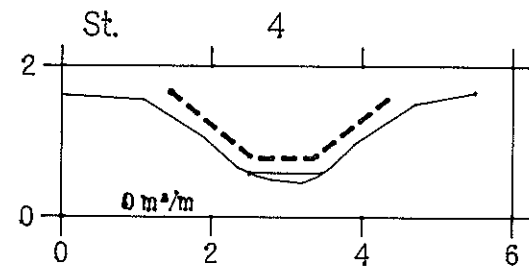

— Opmålt af Hedeselskabet, 1992.
 - - - - - Regulativ

lodret akse : kote i m skala 1:100
 vandret akse : afstand i m skala 1:100

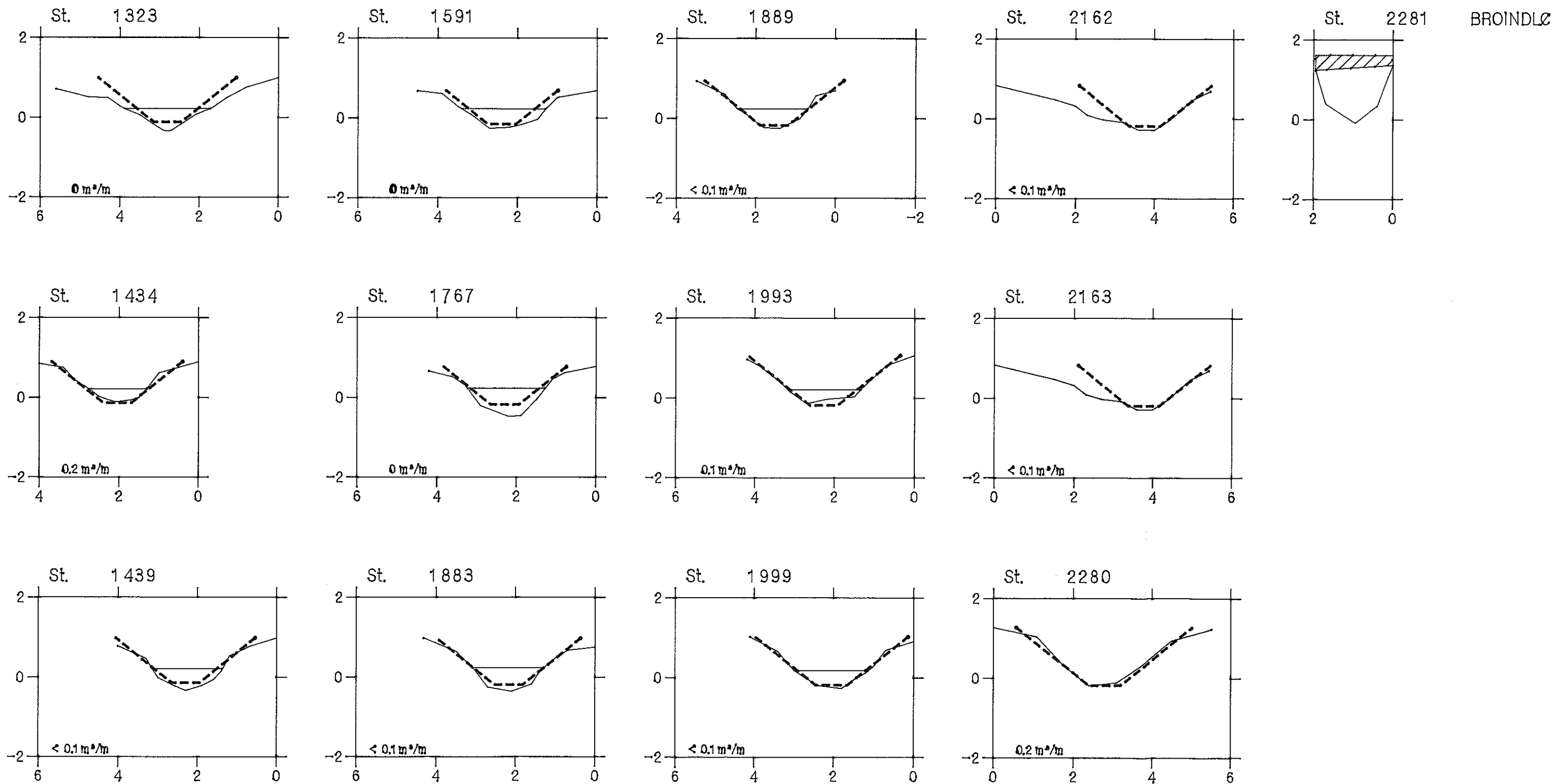

BILDSØ Å

VASP 

— Opmålt af Hedeselskabet, 1992.

- - - - - Regulativ

lodret akse : kote i m skala 1:100
 vandret akse : afstand i m skala 1:100

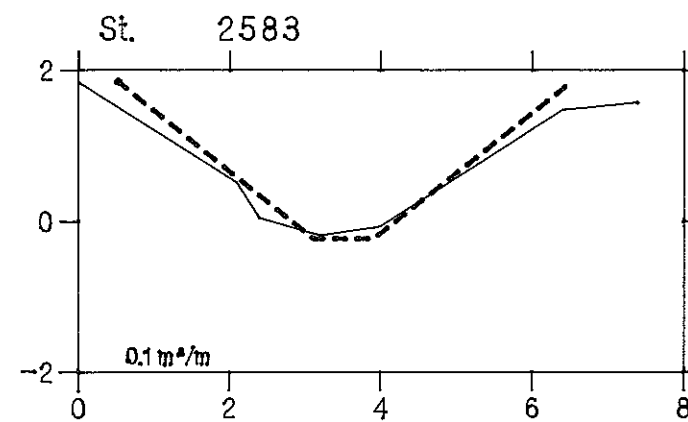
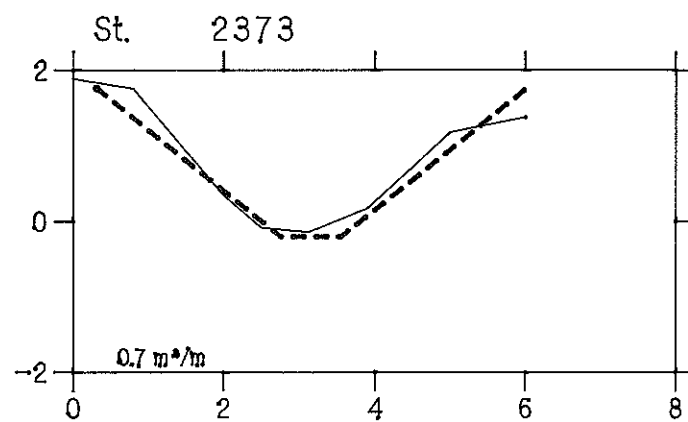
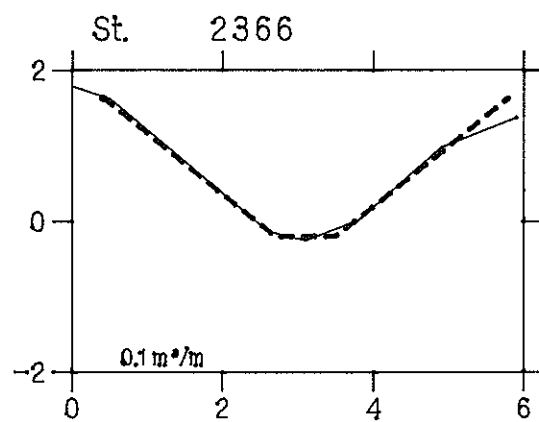
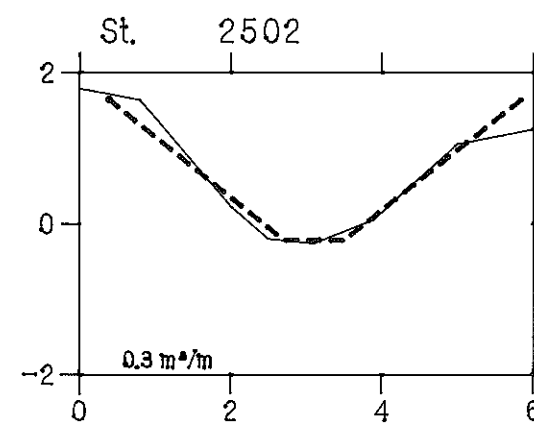
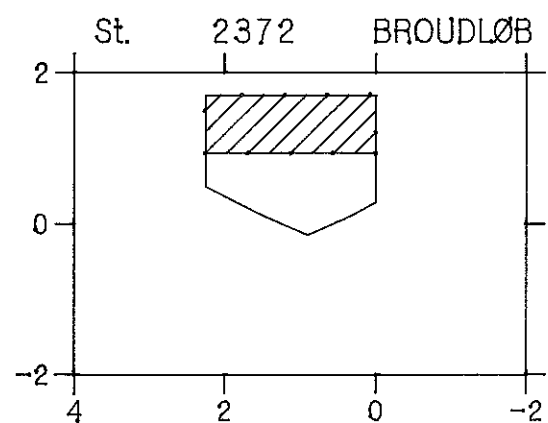
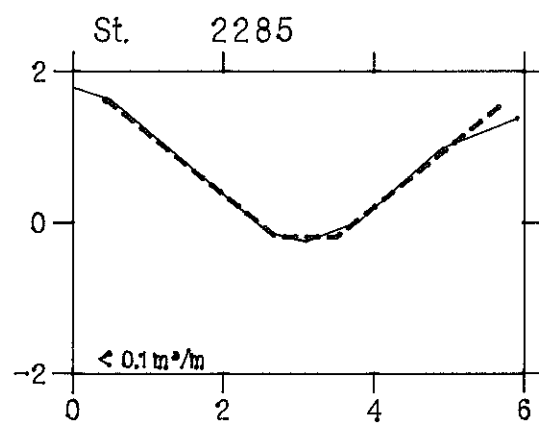
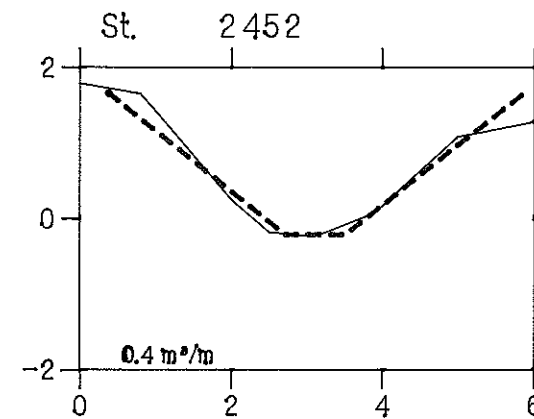
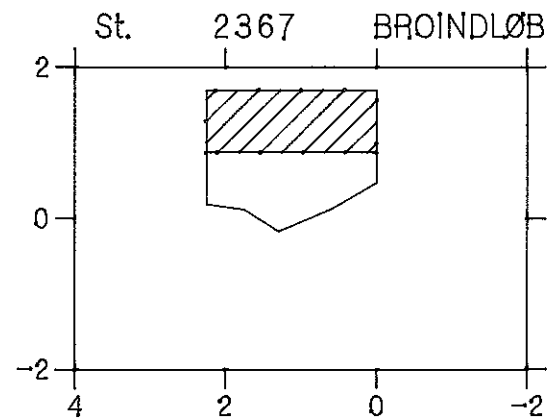
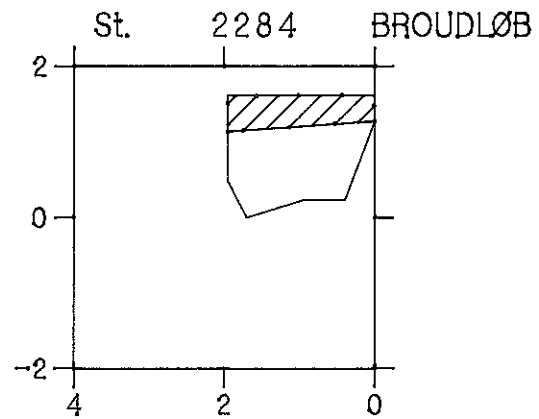



— Opmålt af Hedeselskabet, 1992.

- - - - - Regulativ

lodret akse : kote i m skala 1:100
vandret akse : afstand i m skala 1:100

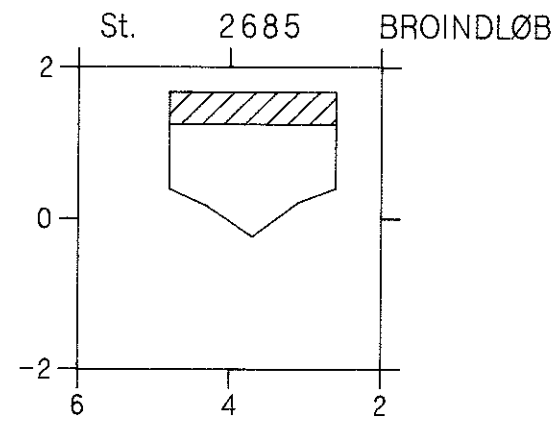
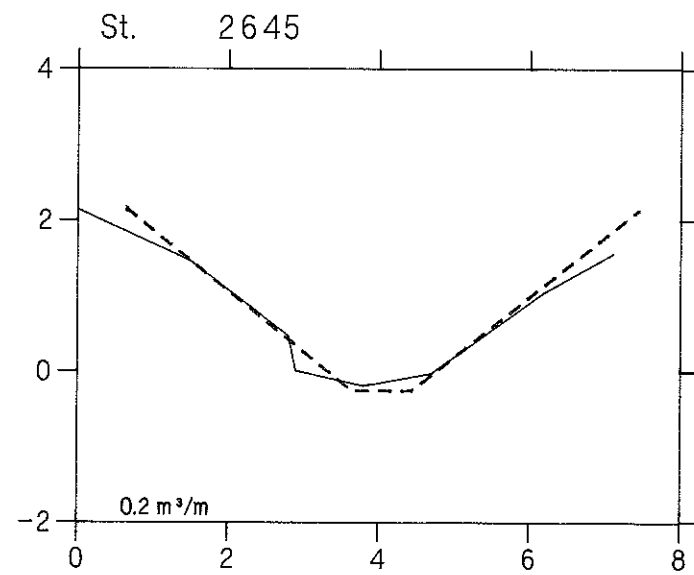
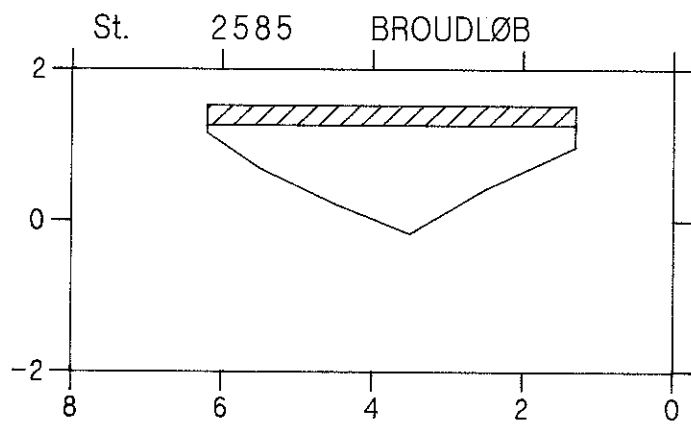
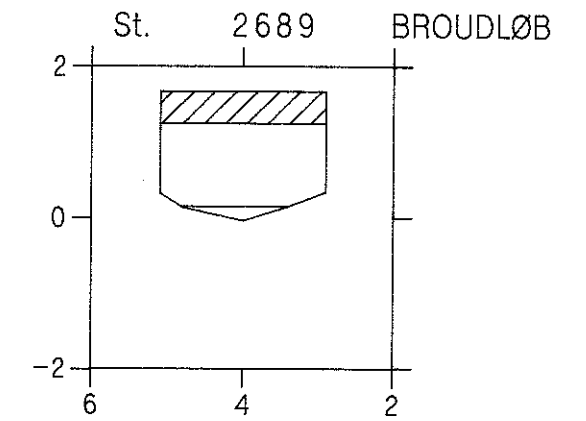
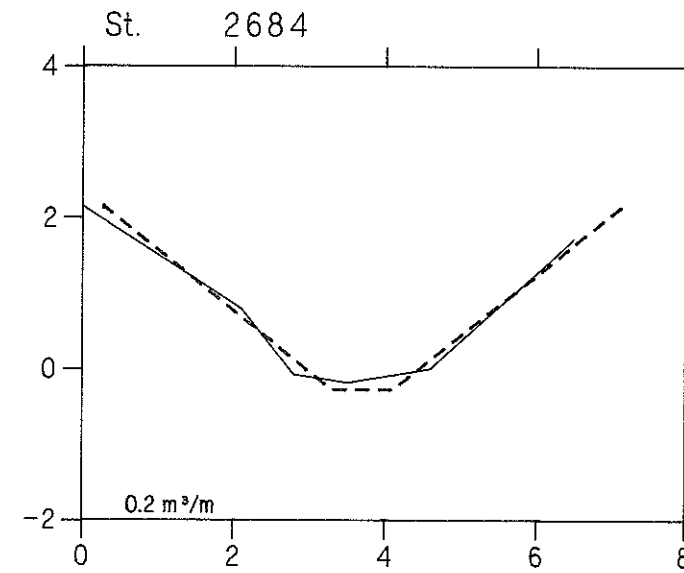
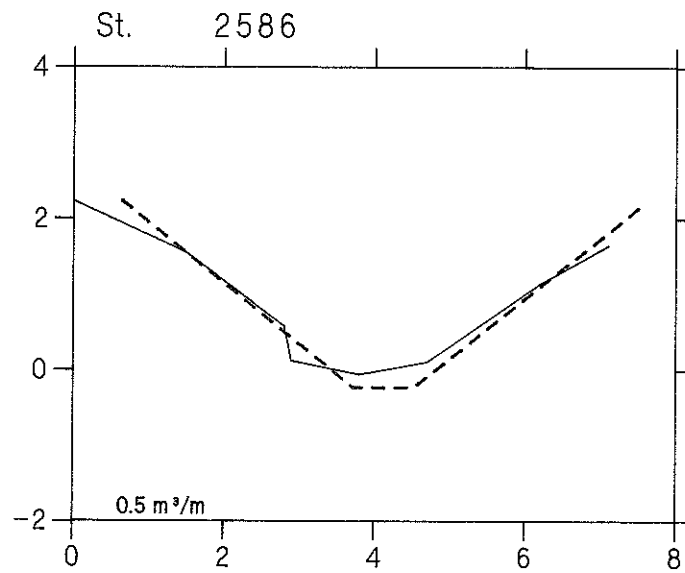
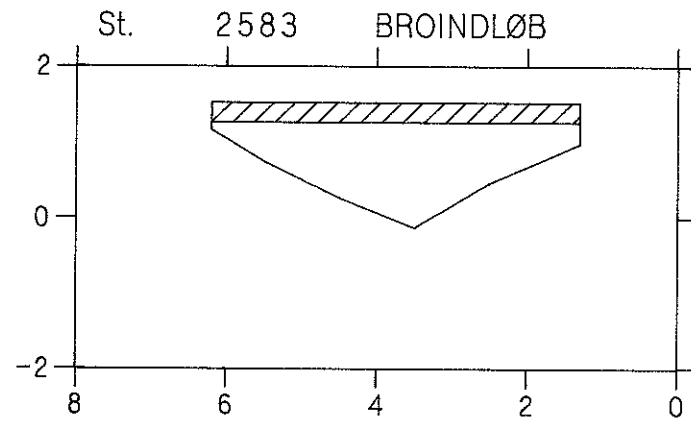



— Opmålt af Hedeselskabet, 1992.

- - - - - Regulativ

Iodret akse : kote i m skala 1:100

vandret akse : afstand i m skala 1:100

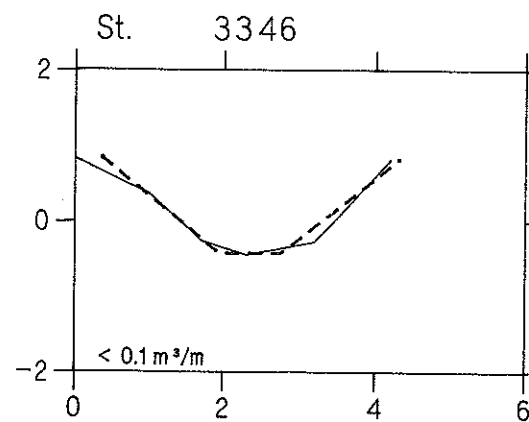
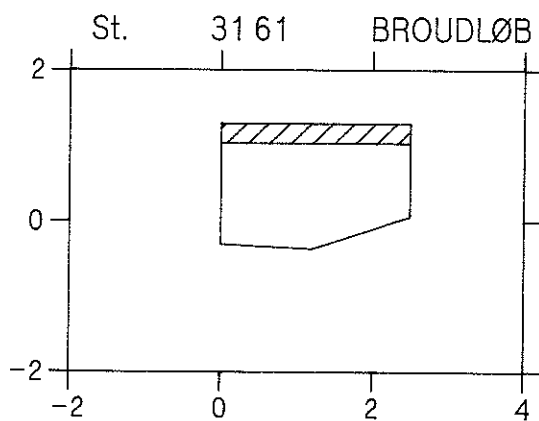
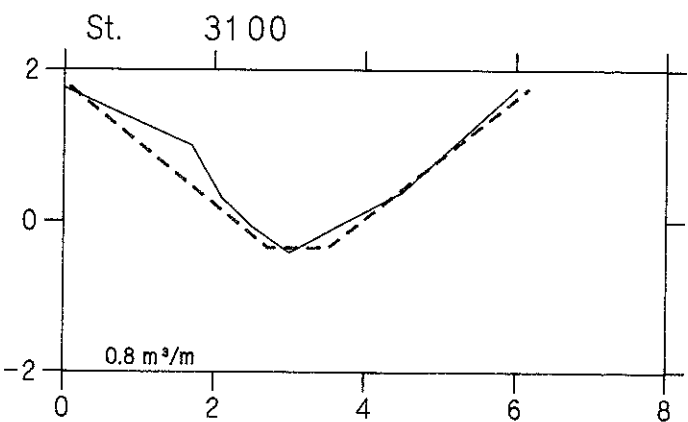
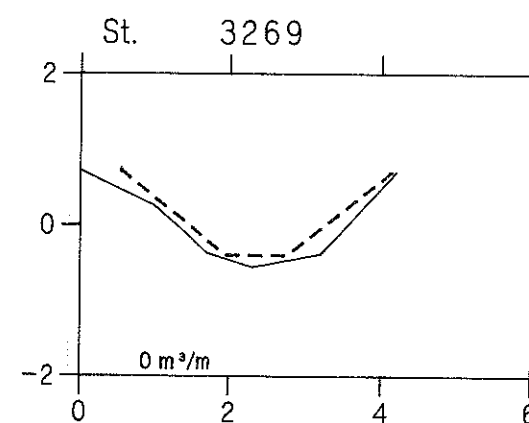
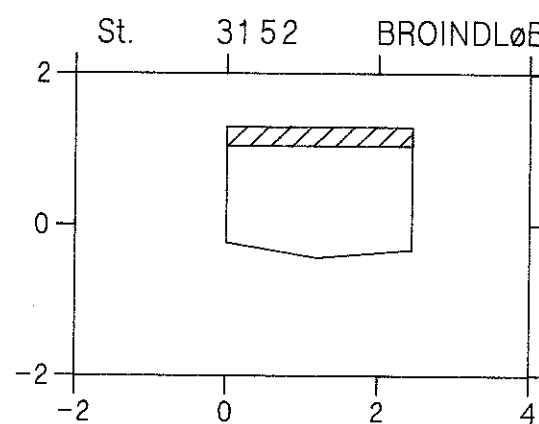
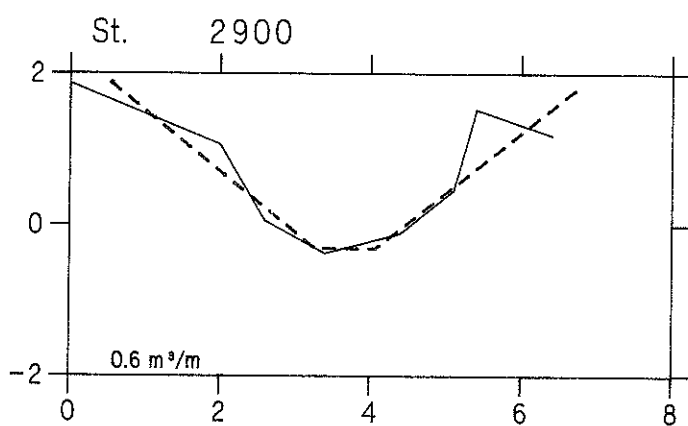
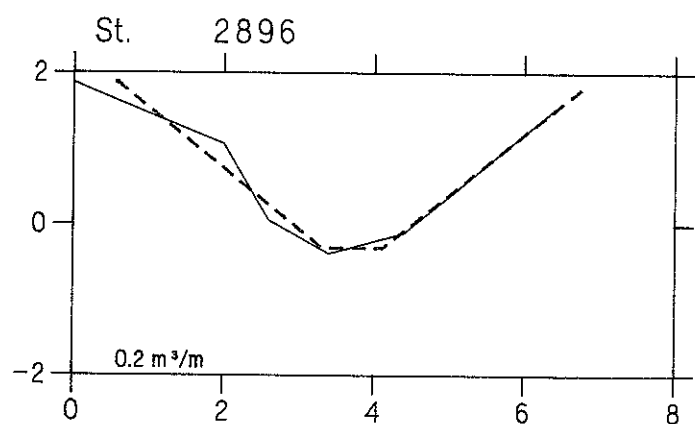
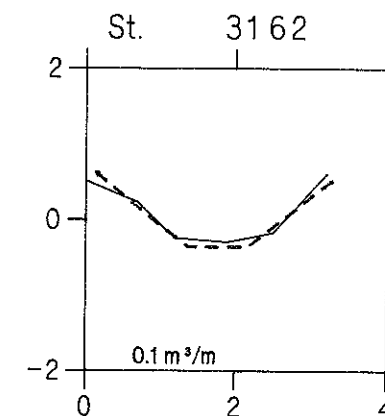
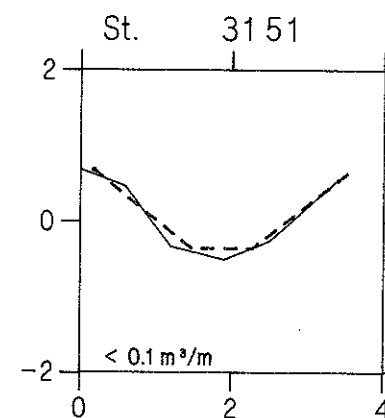
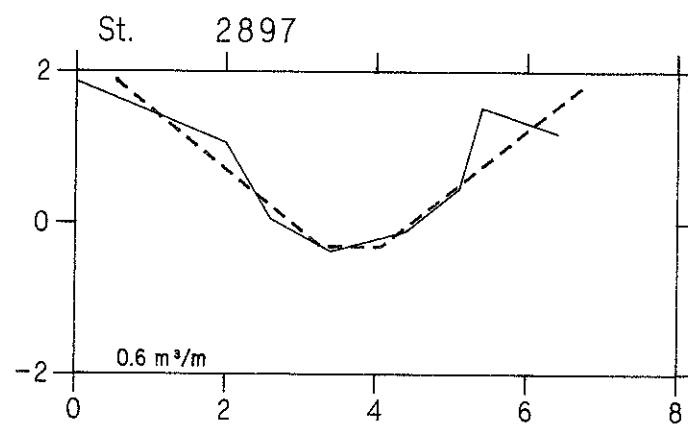
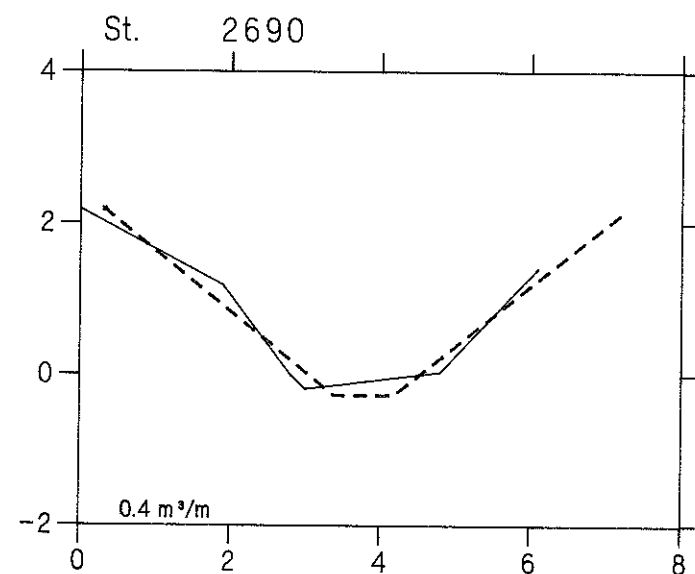

BILDSØ Å

VASP 

— Opmålt af Hedeselskabet, 1992.

- - - - - Regulativ

lodret akse : kote i m skala 1:100

vandret akse : afstand i m skala 1:100

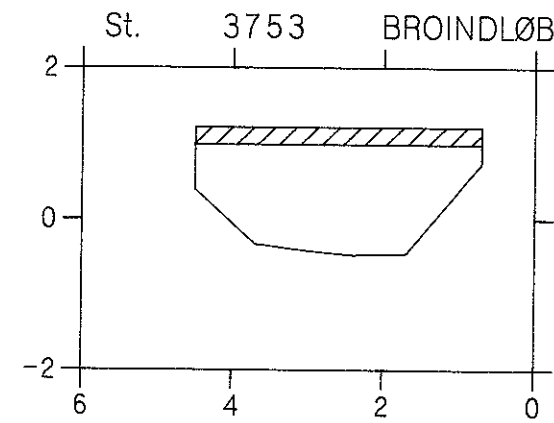
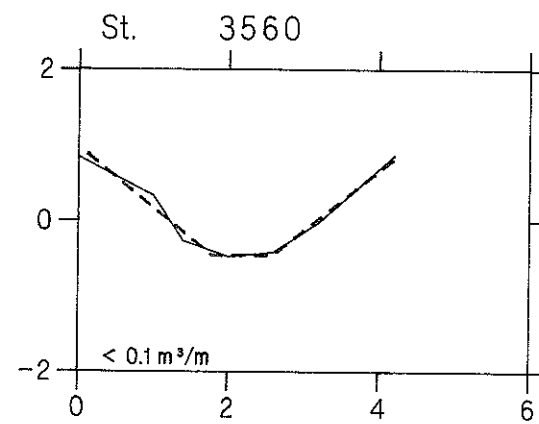
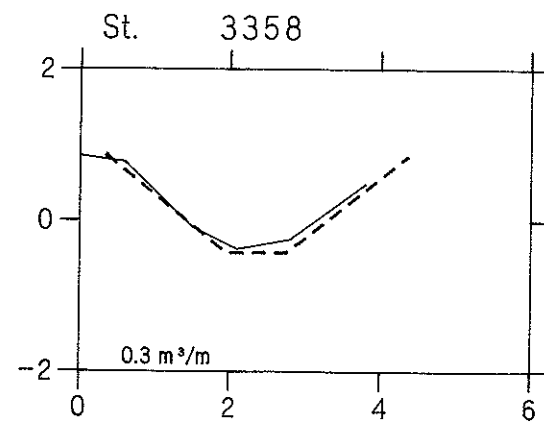
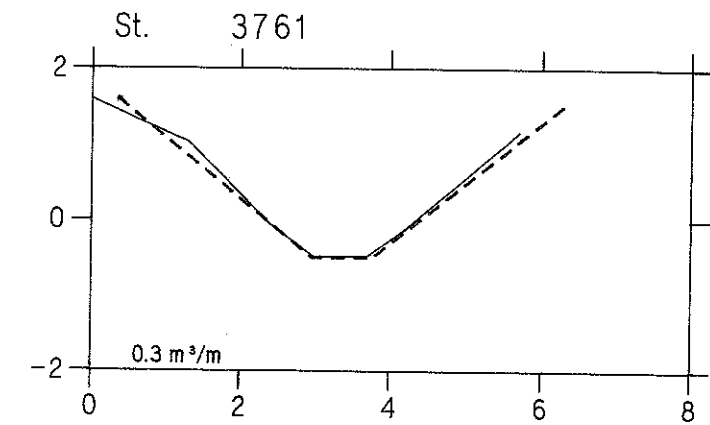
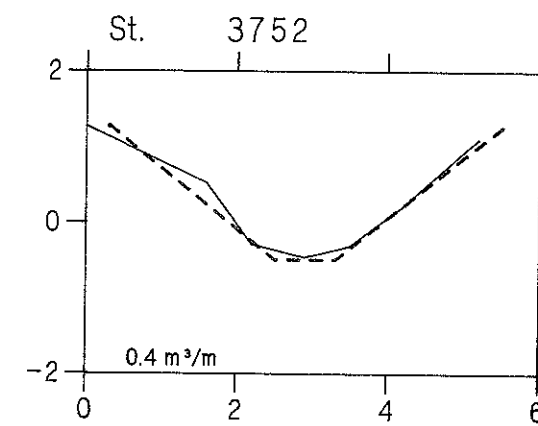
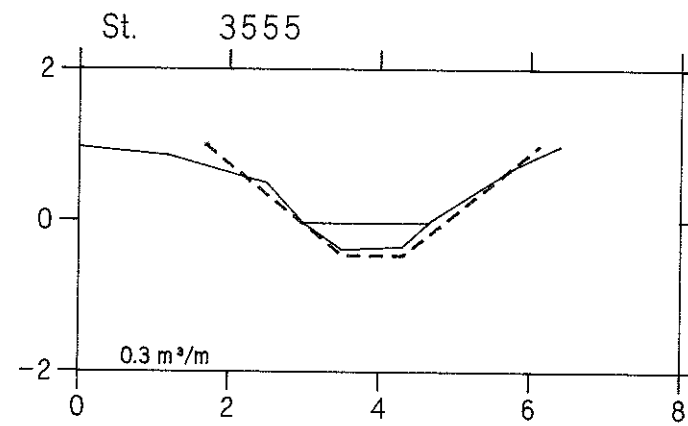
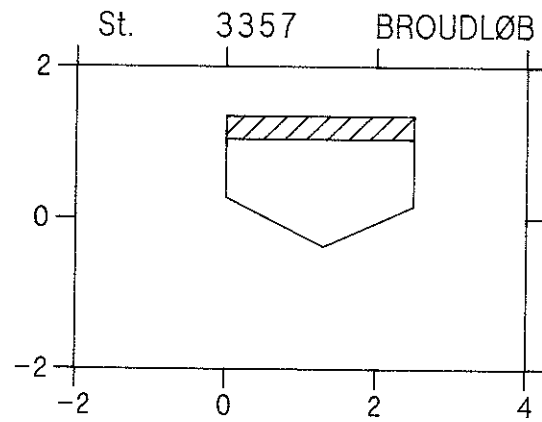
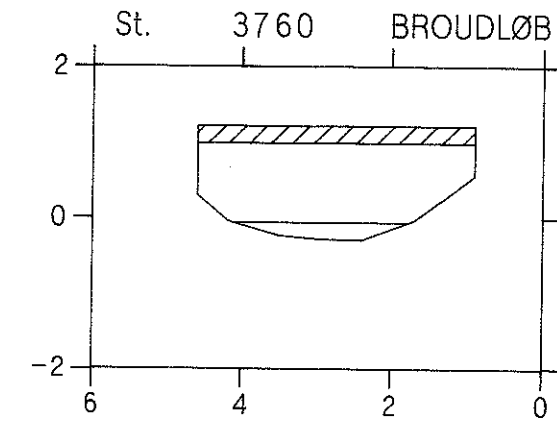
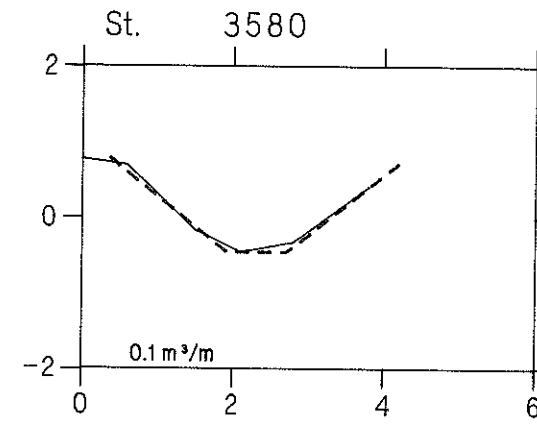
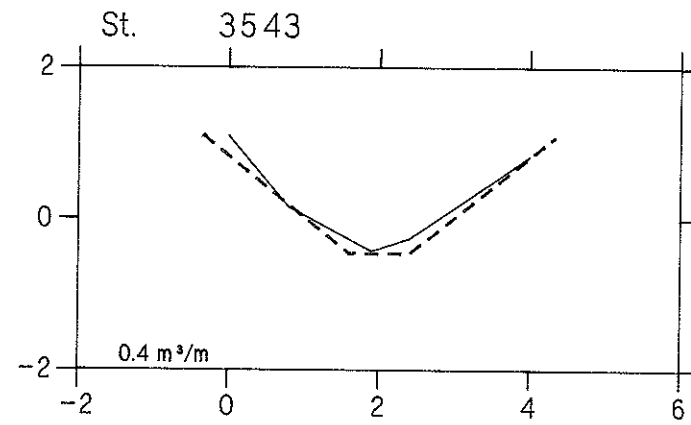
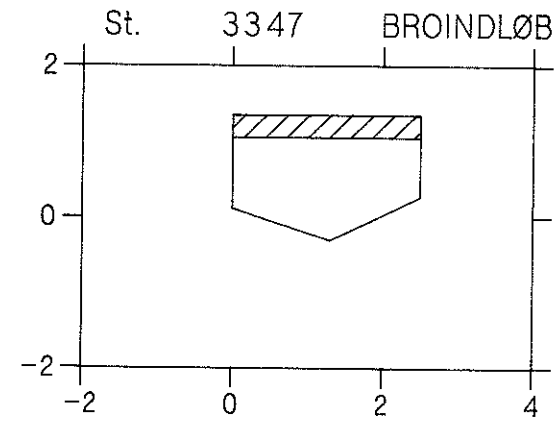

BILDSØ Å

VASP 

— Opmålt af Hedeselskabet, 1992.

- - - - - Regulativ

lodret akse : kote i m skala 1:1 00
 vandret akse : afstand i m skala 1:1 00

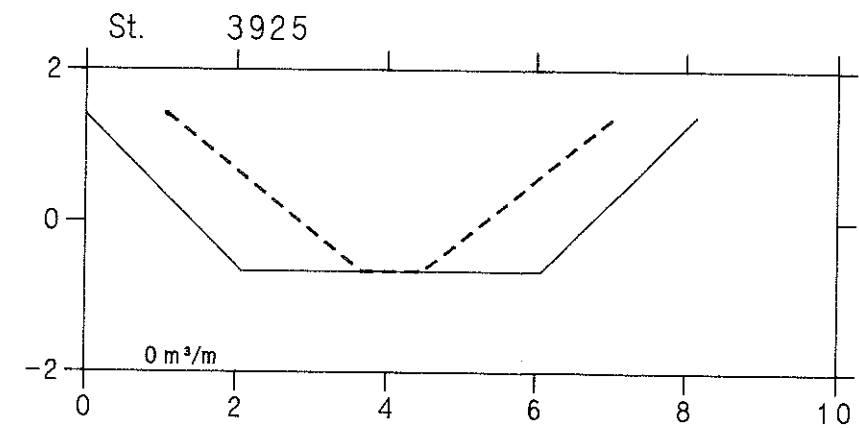
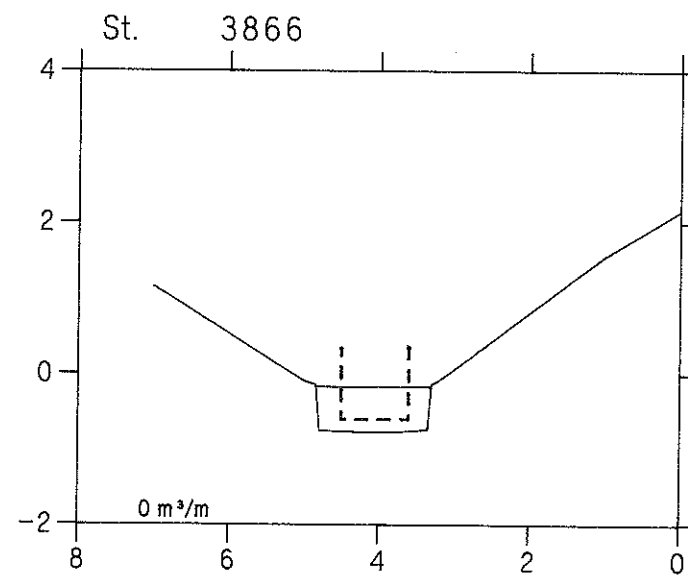
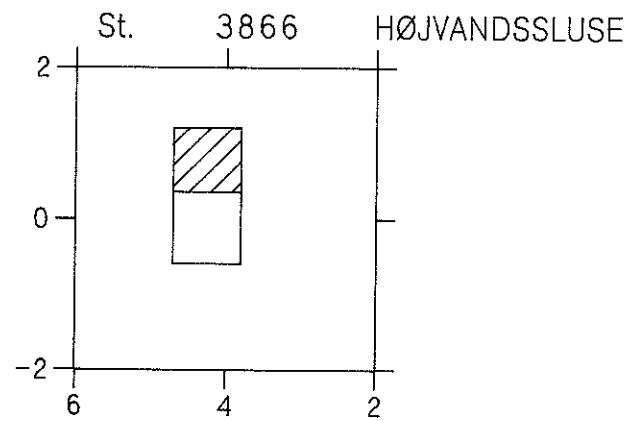
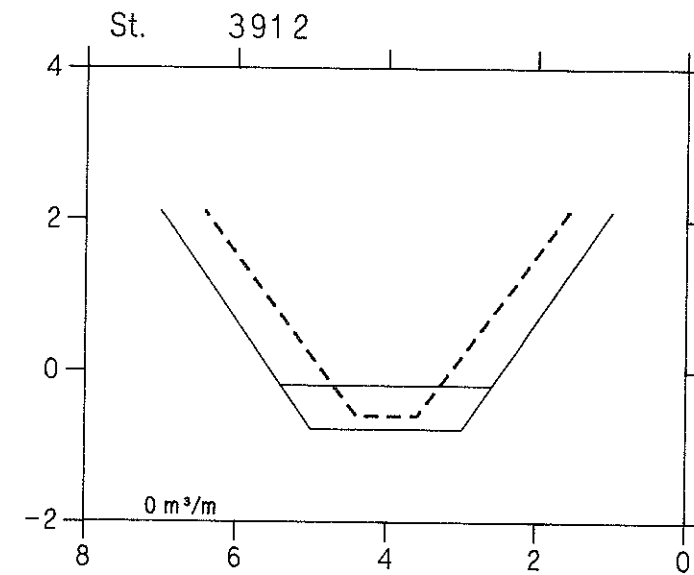
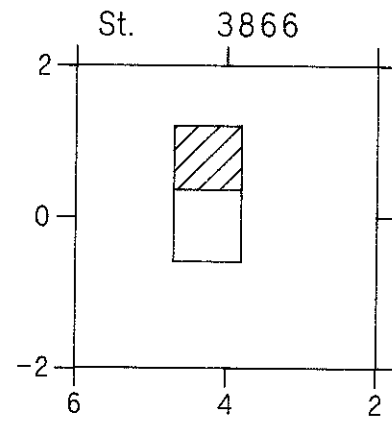
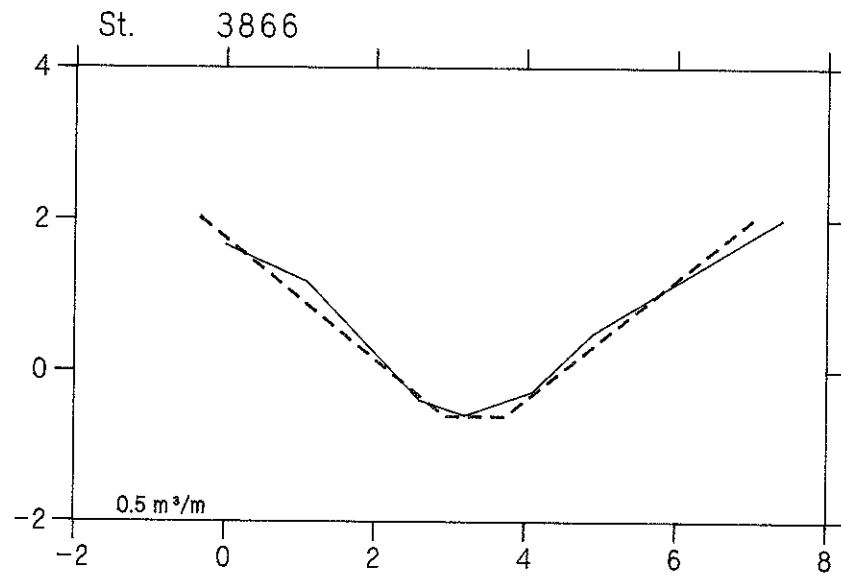

BILDSØ Å

VASP 

— Opmålt af Hedeselskabet, 1992.

- - - - - Regulativ

lodret akse : kote i m skala 1:100
vandret akse : afstand i m skala 1:100

