

BØSTRUPRENDEN, HOVEDLØB



VASP

Lodret akse : kote i m skala 1:100

— Opmålt af Hedeselskabet 1989

Vandret akse : afstand i m skala 1:100

- - - Nyt regulativ

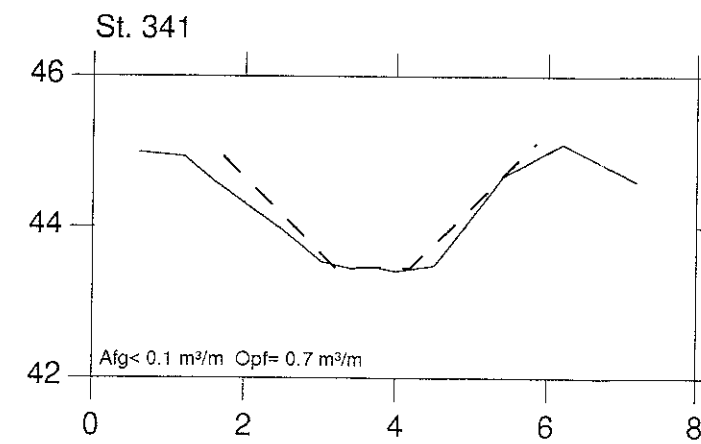
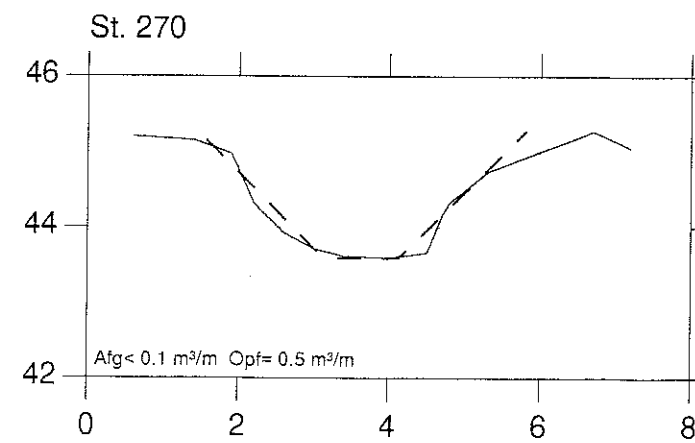
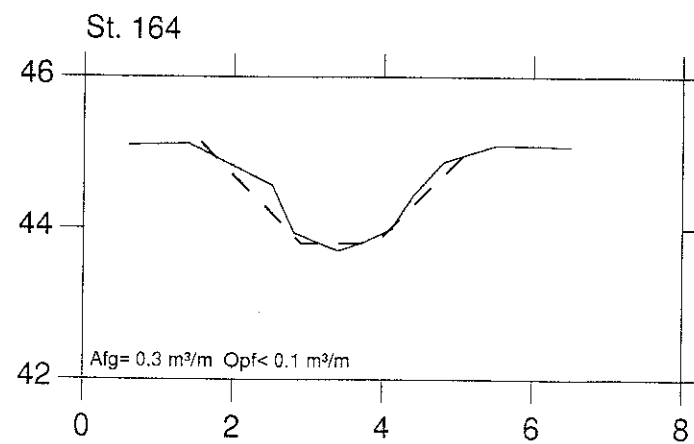
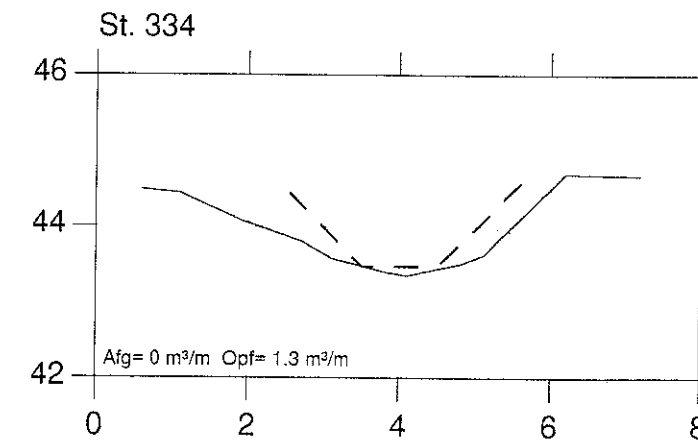
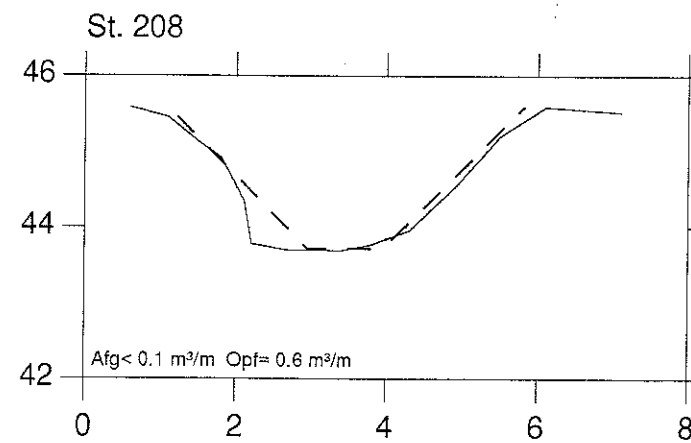
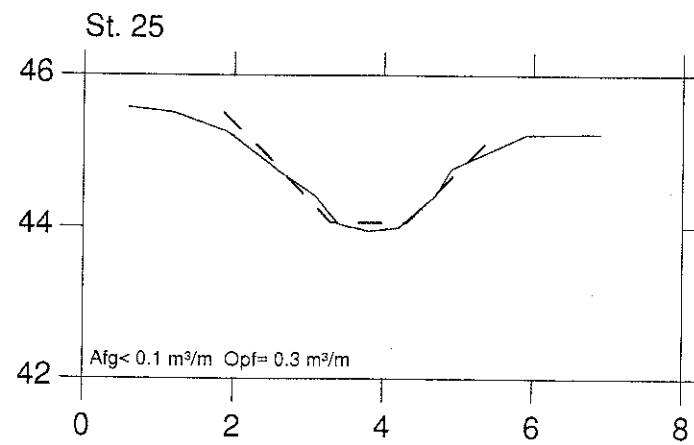
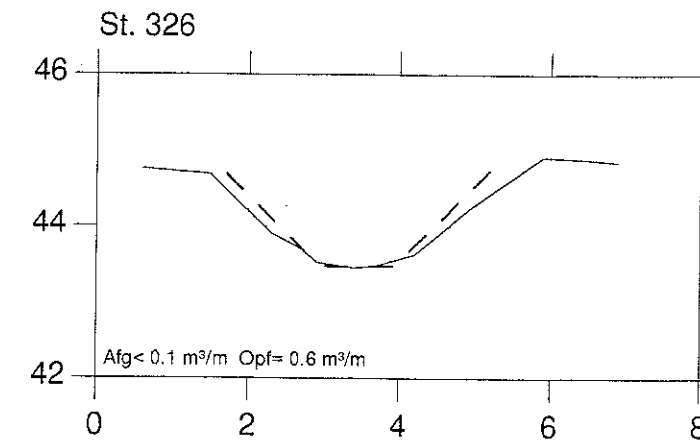
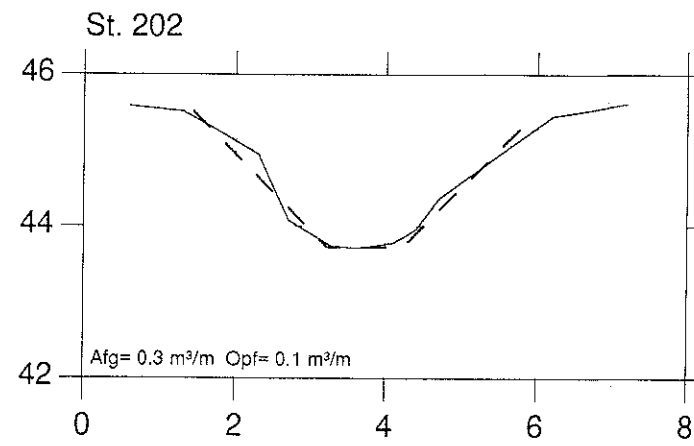
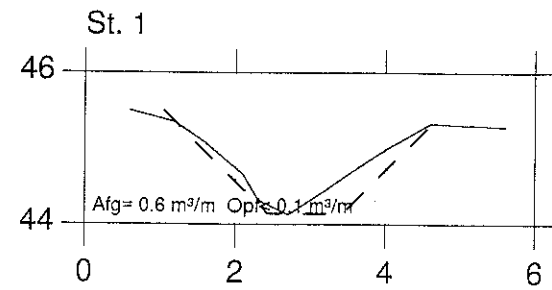

BØSTRUPRENDEN, HOVEDLØB

VASP 

Lodret akse : kote i m skala 1:100

Vandret akse : afstand i m skala 1:100

— Opmålt af Hedeselskabet 1989

- - - Nyt regulativ

Hashøj Kommune

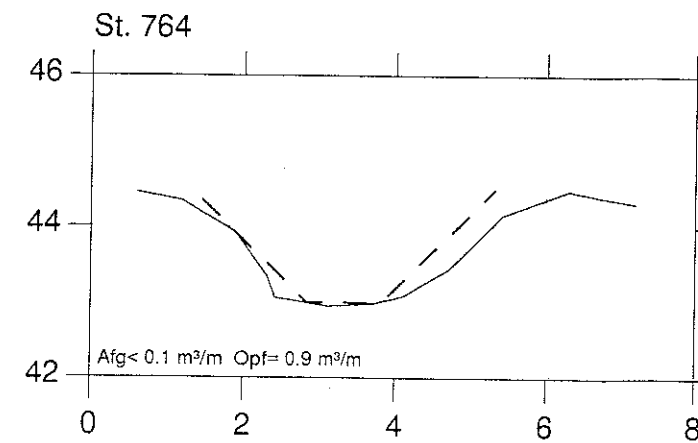
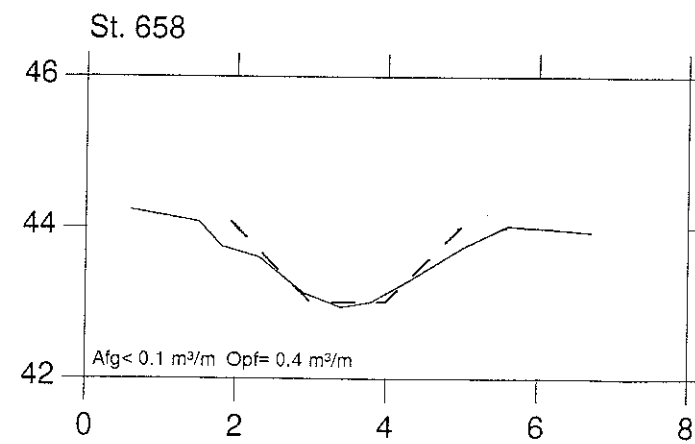
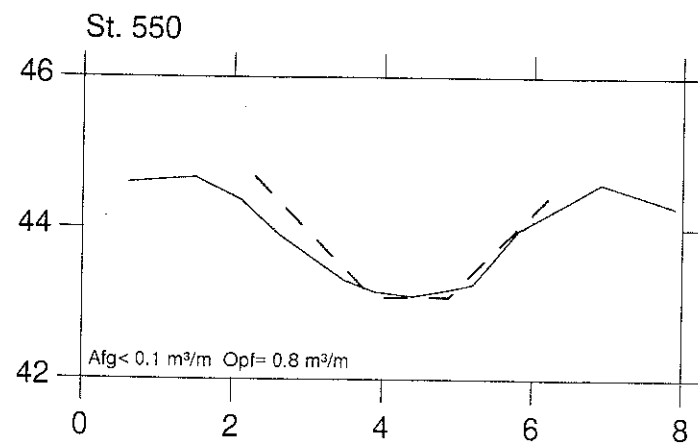
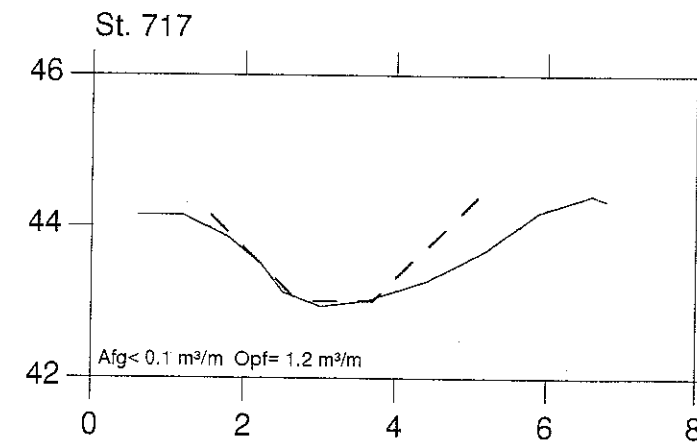
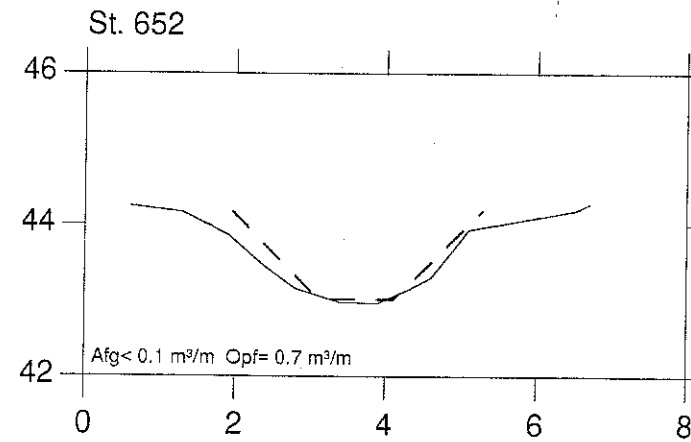
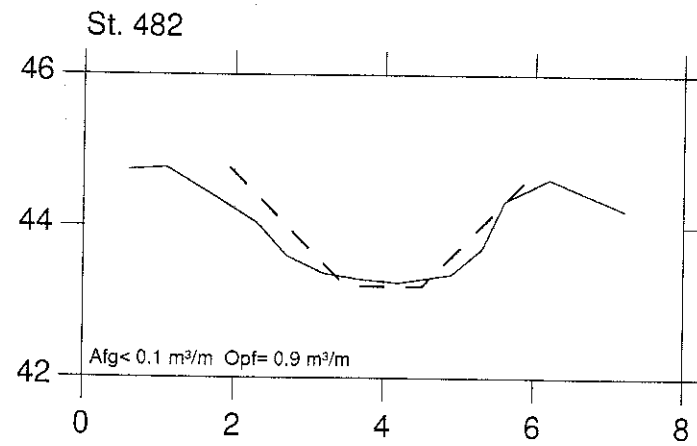
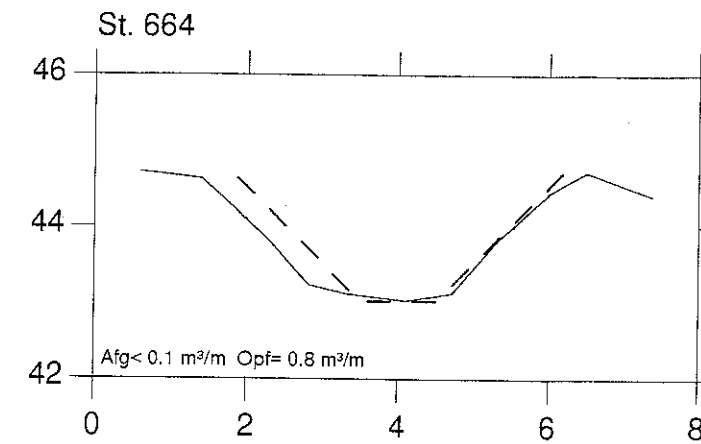
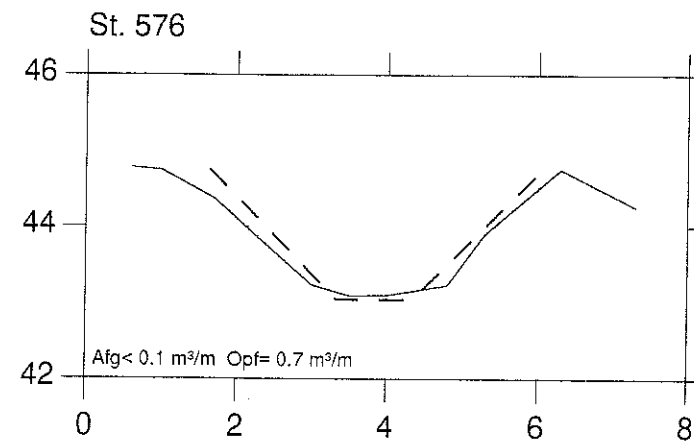
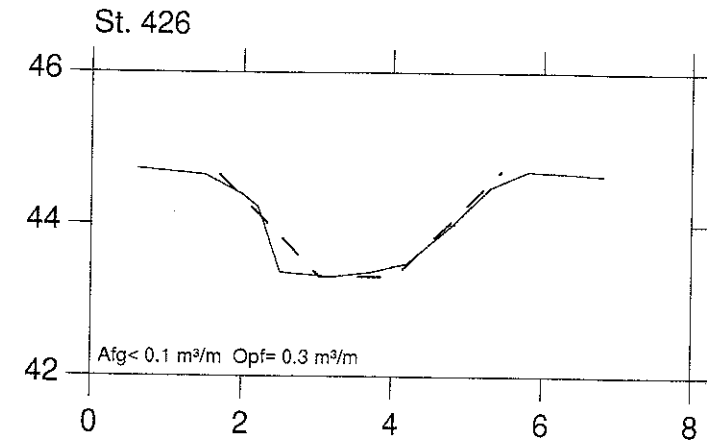

BØSTRUPRENDEN, HOVEDLØB

VASP

Lodret akse : kote i m skala 1:100

— Opmålt af Hedeselskabet 1989

Vandret akse : afstand i m skala 1:100

- - - Nyt regulativ

Hashøj Kommune

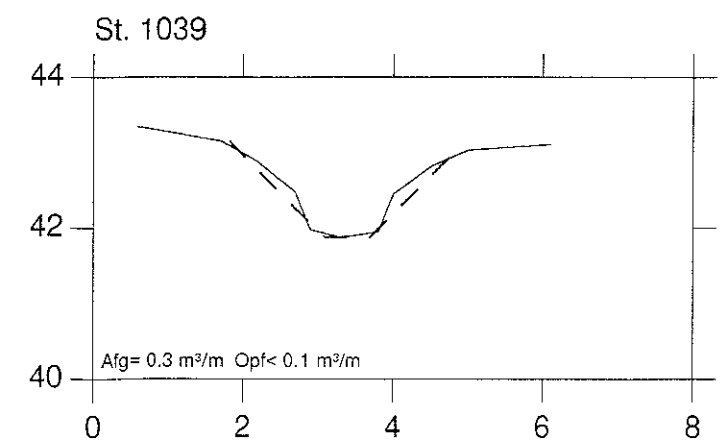
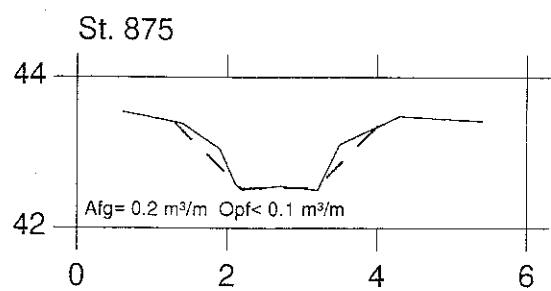
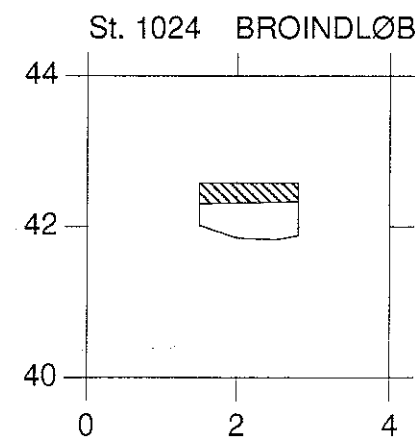
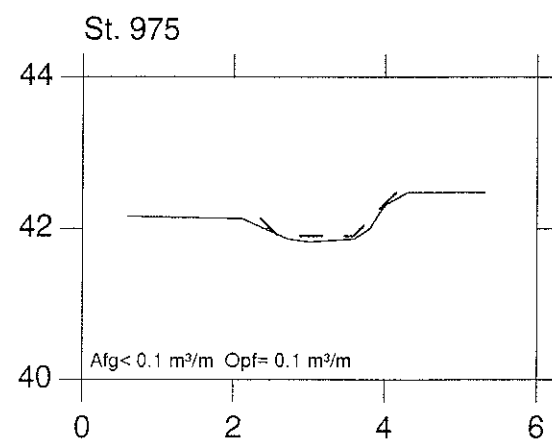
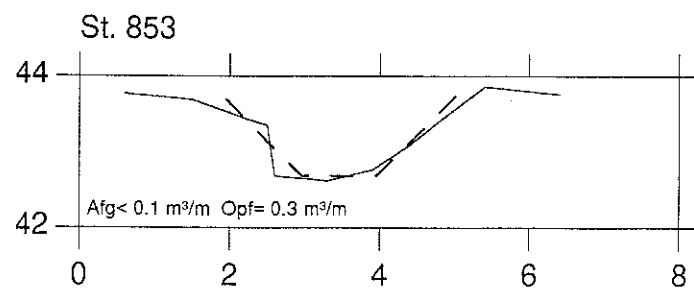
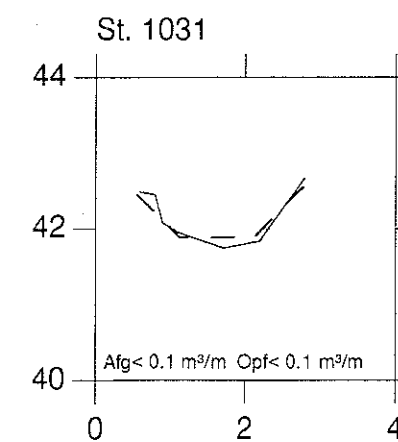
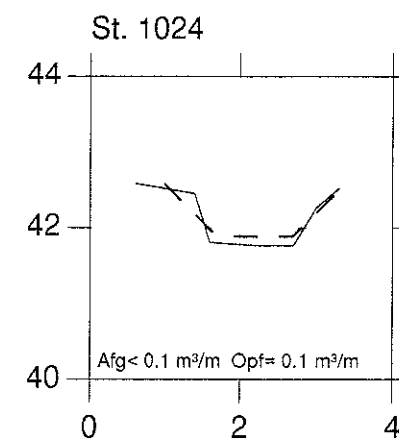
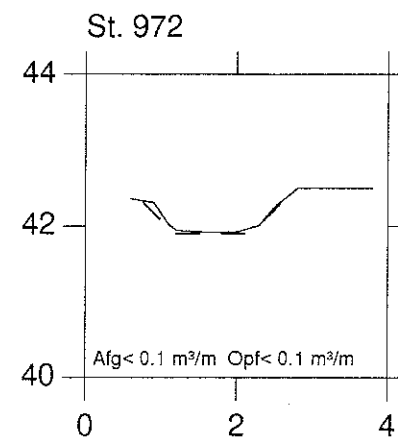
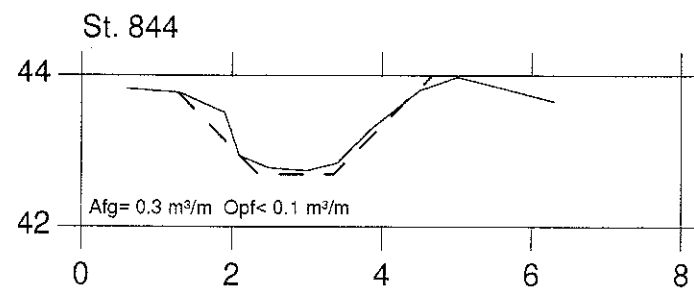
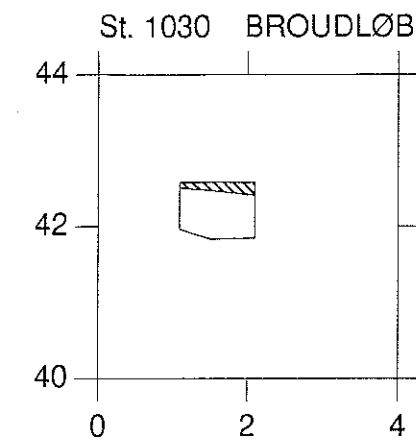
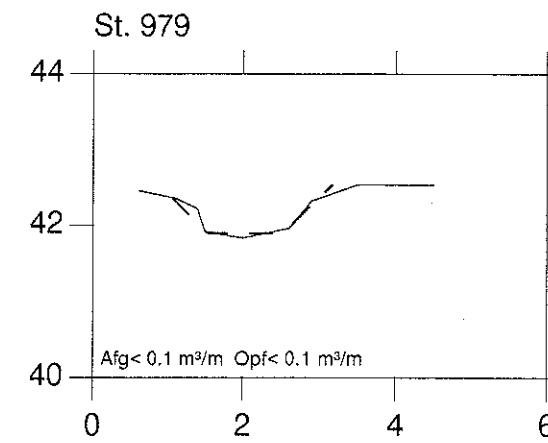
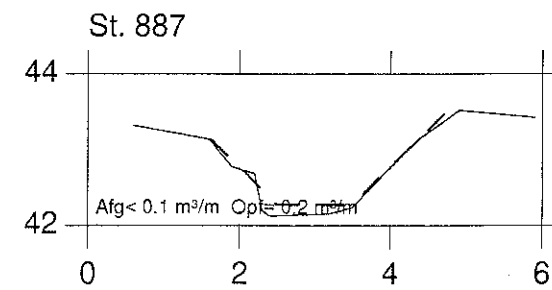
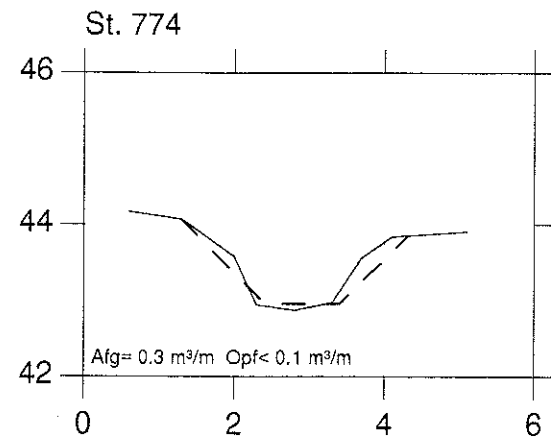

BØSTRUPRENDEN, HOVEDLØB

VASP 

Lodret akse : kote i m skala 1:100

— Opmålt af Hedeselskabet 1989

Vandret akse : afstand i m skala 1:100

- - - Nyt regulativ

Hashøj Kommune

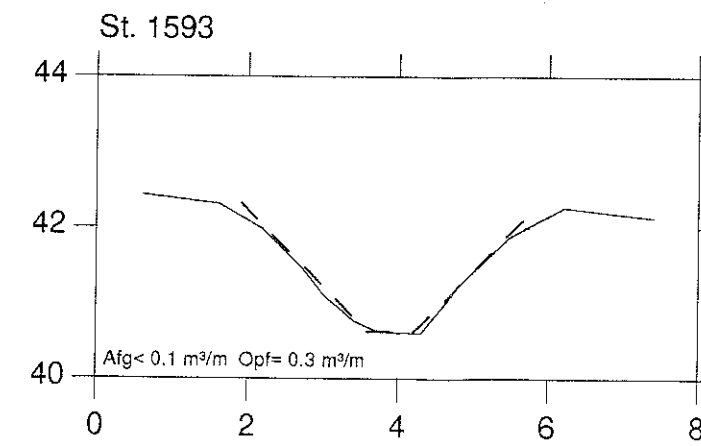
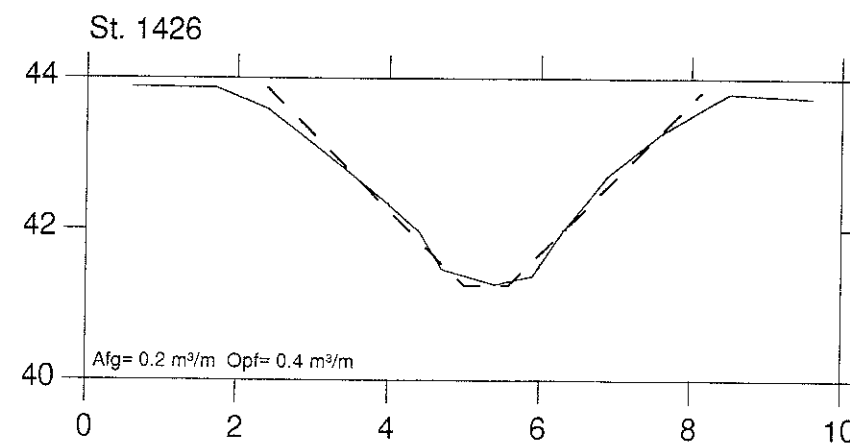
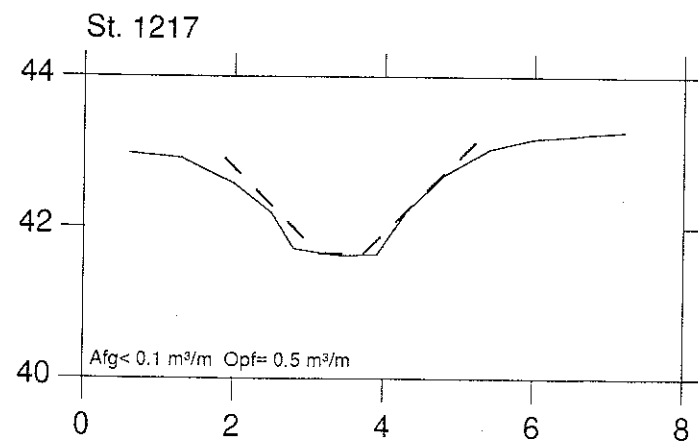
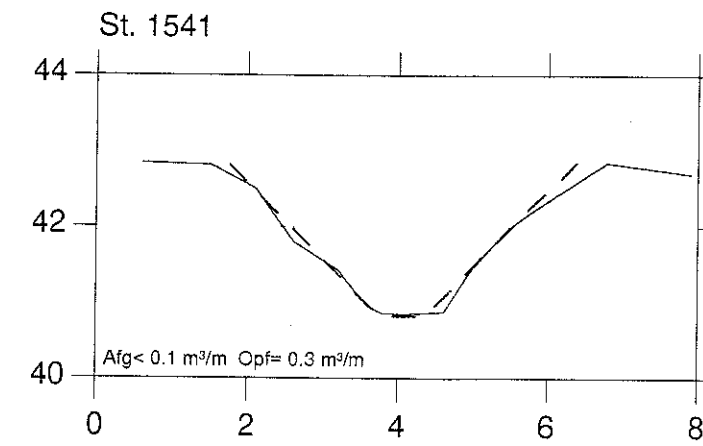
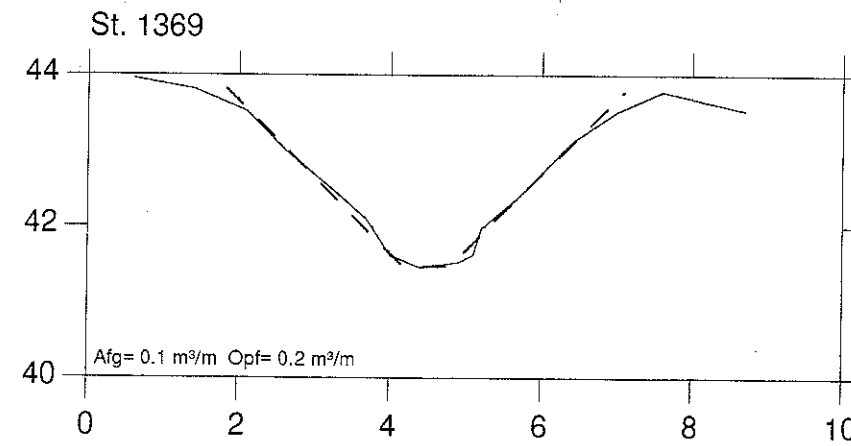
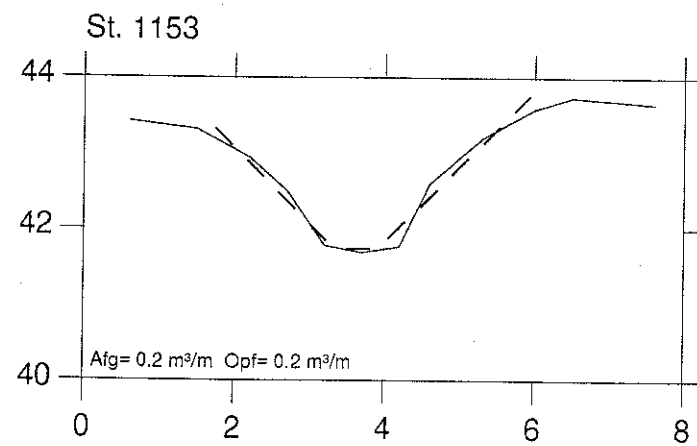
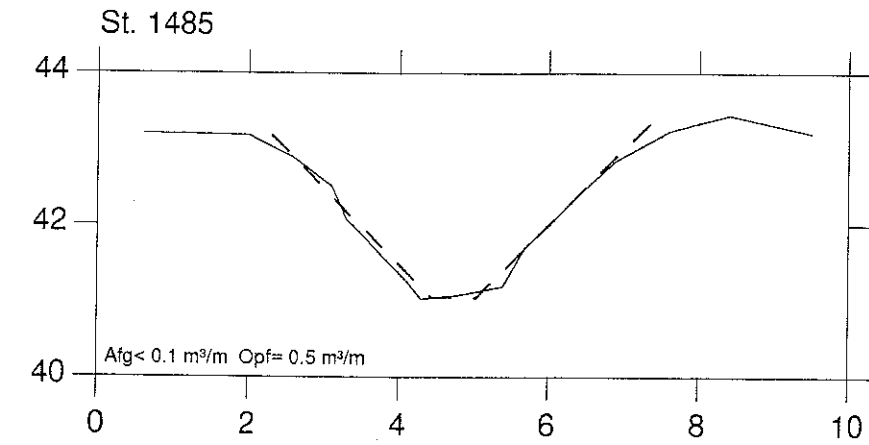
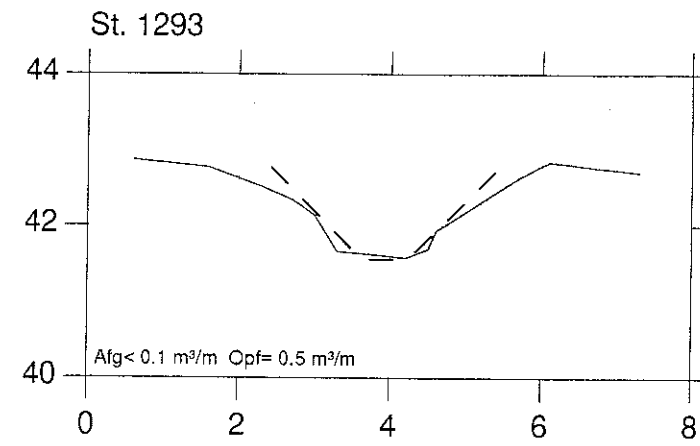
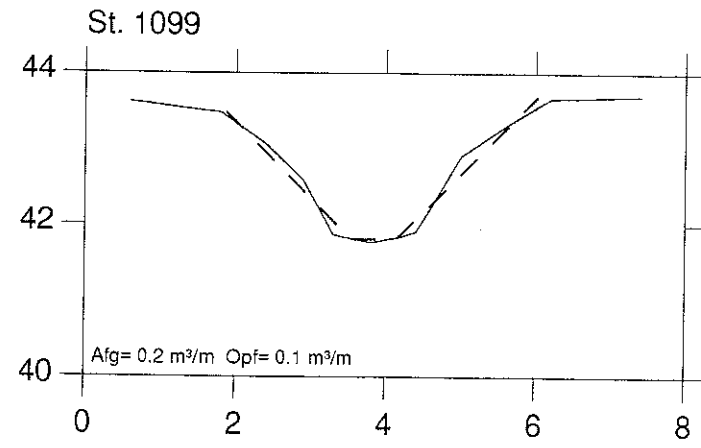

BØSTRUPRENDEN, HOVEDLØB

VASP 

Lodret akse : kote i m skala 1:100

— Opmålt af Hedeselskabet 1989

Vandret akse : afstand i m skala 1:100

- - - Nyt regulativ

Hashøj Kommune

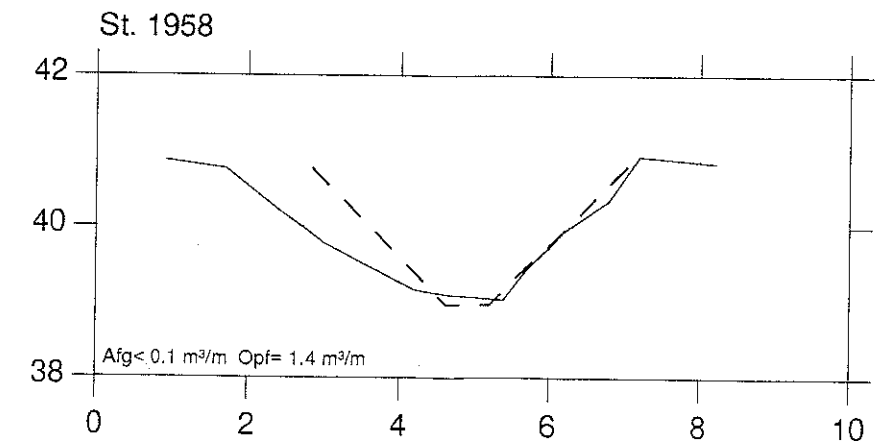
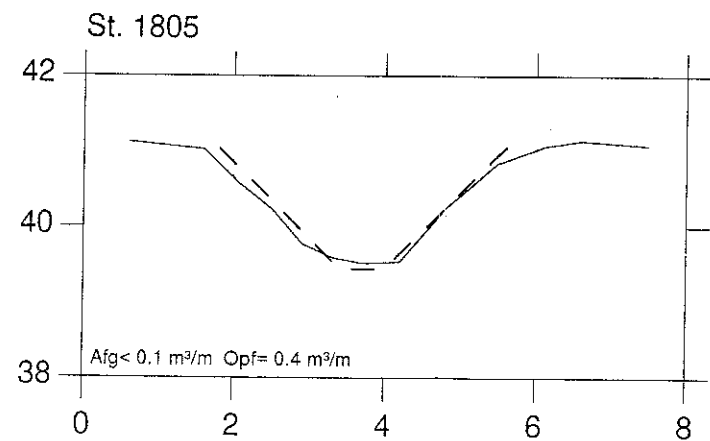
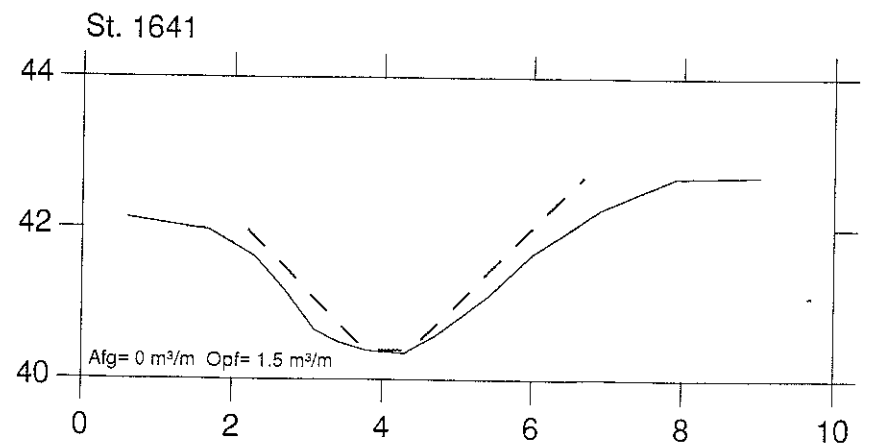
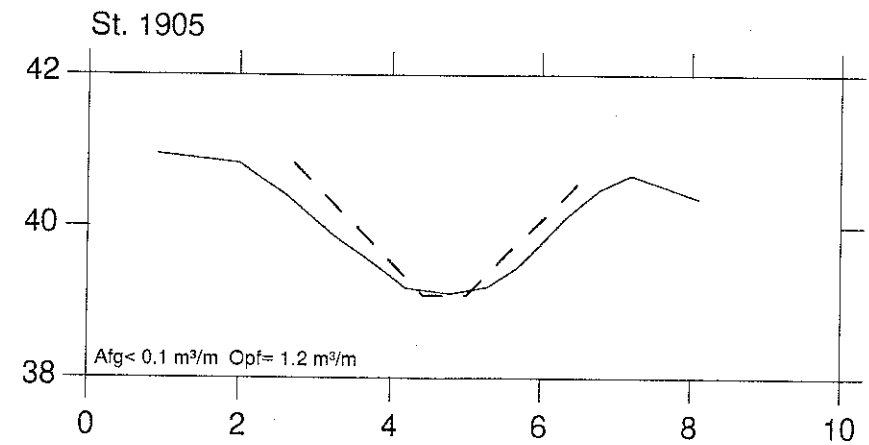
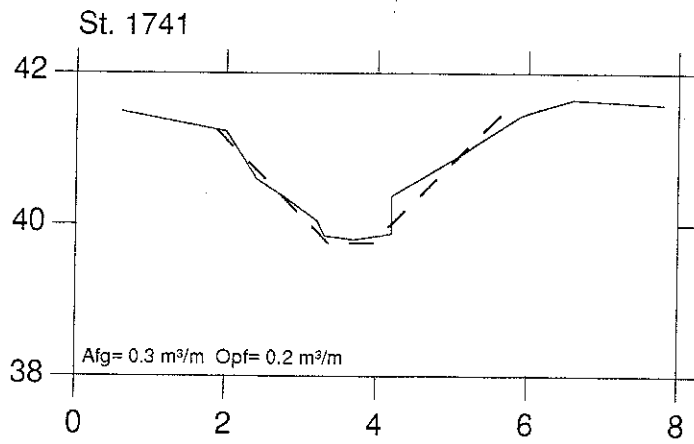
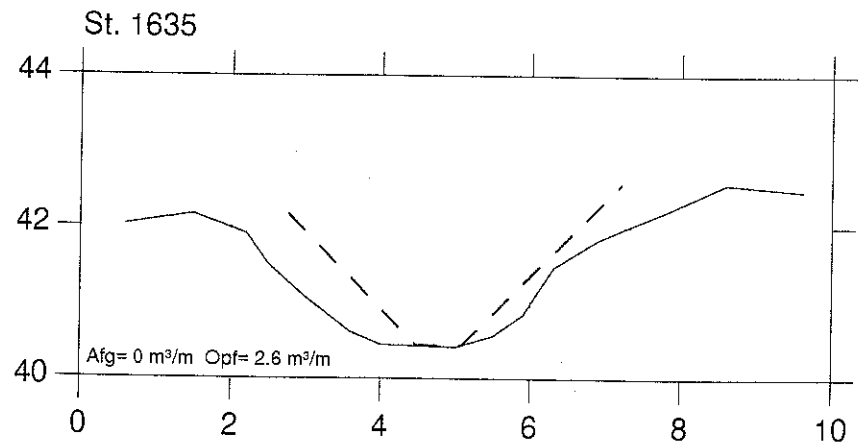
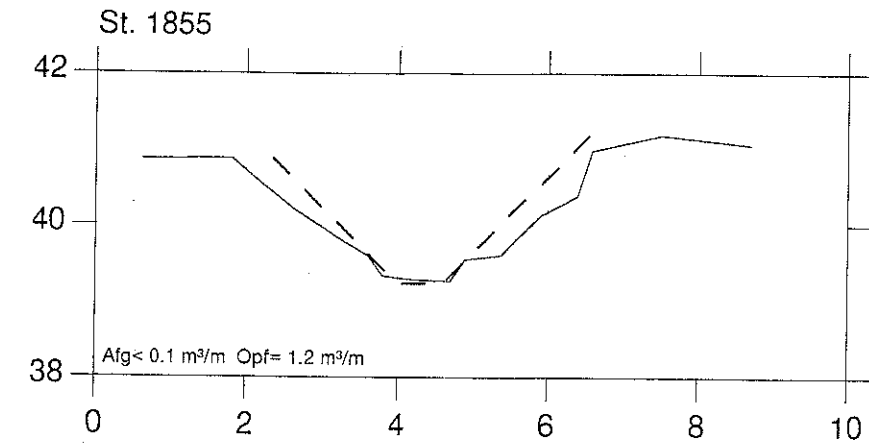
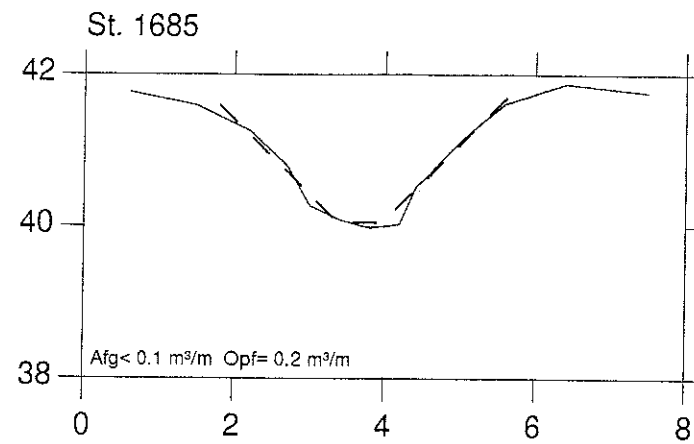
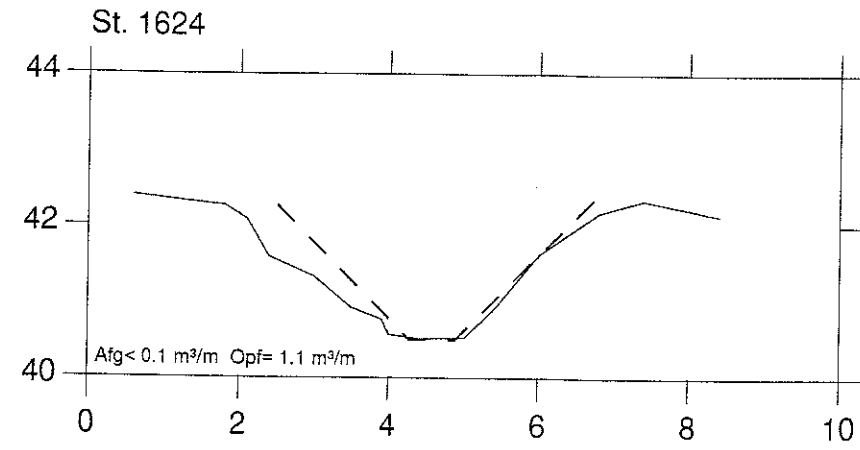

BØSTRUPRENDEN, HOVEDLØB

VASP 

Lodret akse :kote i m skala 1:100

— Opmålt af Hedeselskabet 1989

Vandret akse : afstand i m skala 1:100

- - - Nyt regulativ

Hashøj Kommune

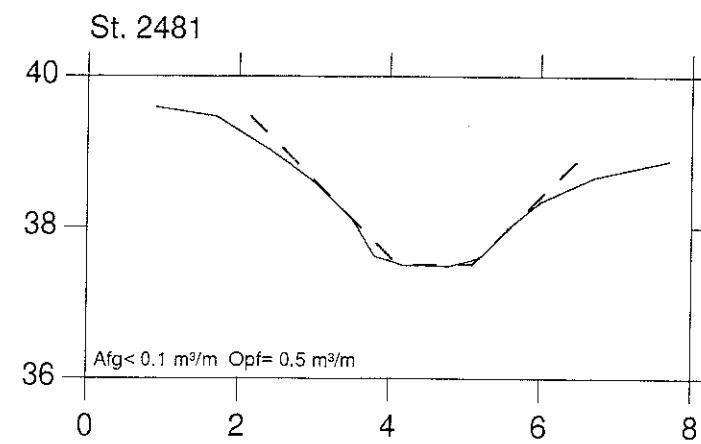
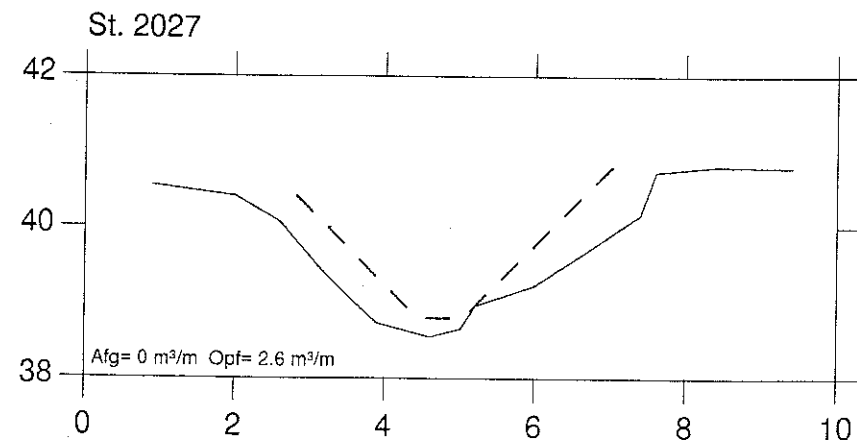
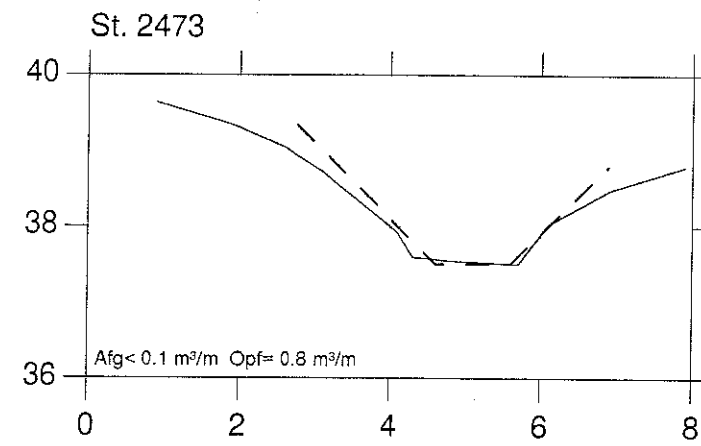
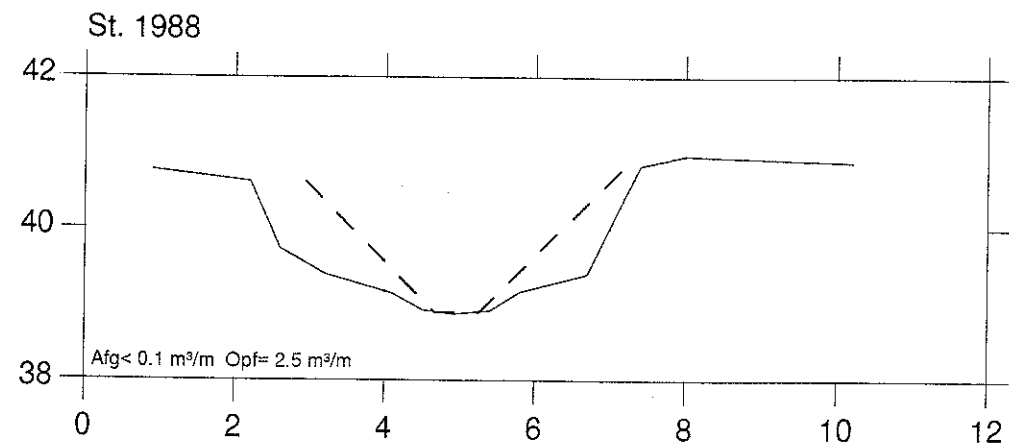
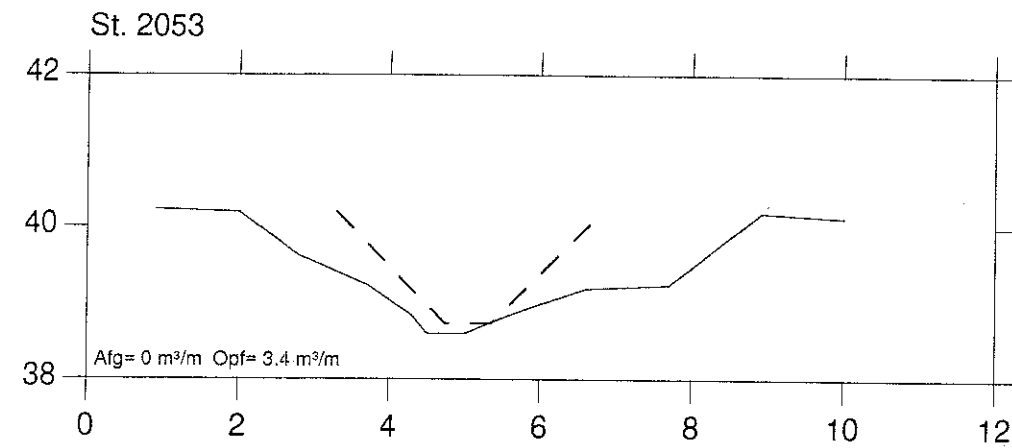
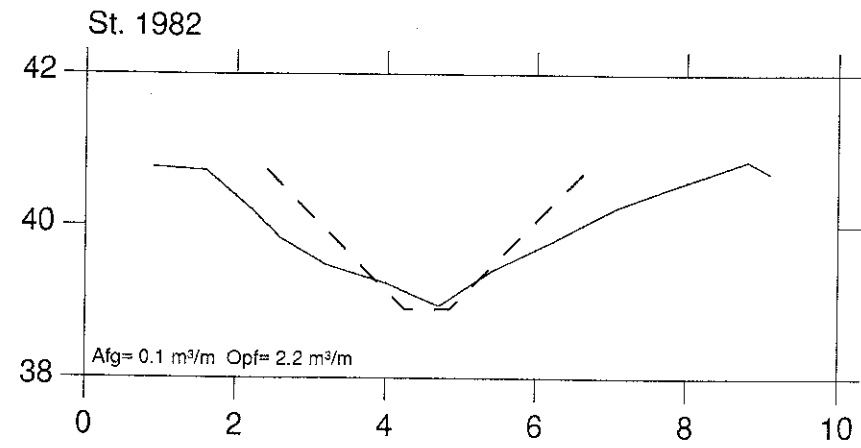

BØSTRUPRENDEN, HOVEDLØB

VASP 

Lodret akse : kote i m skala 1:100

— Opmålt af Hedeselskabet 1989

Vandret akse : afstand i m skala 1:100

- - - Nyt regulativ

Hashøj Kommune

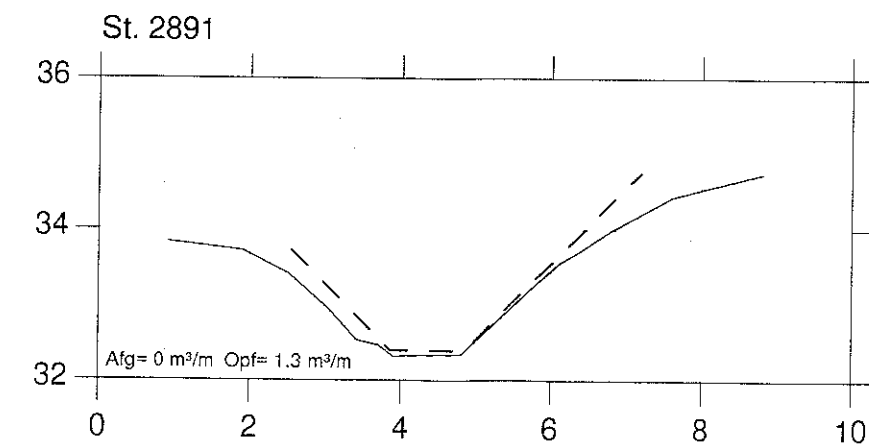
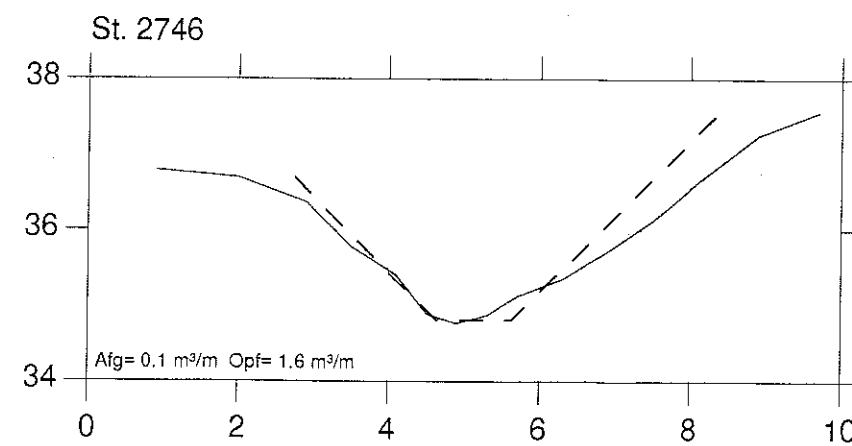
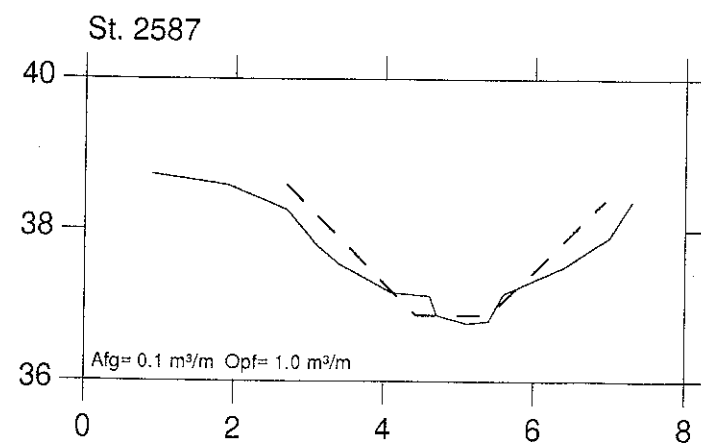
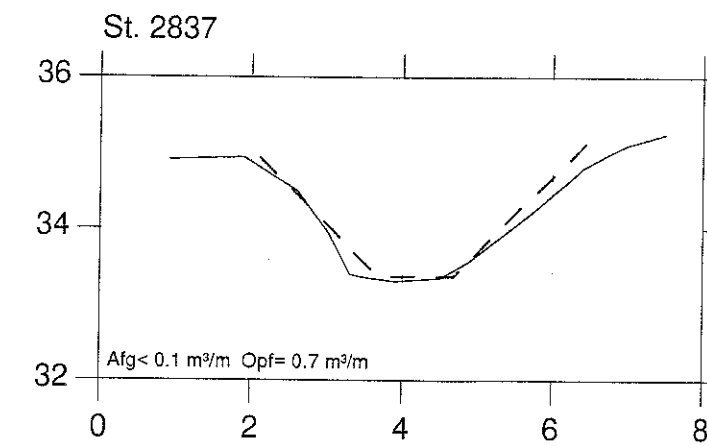
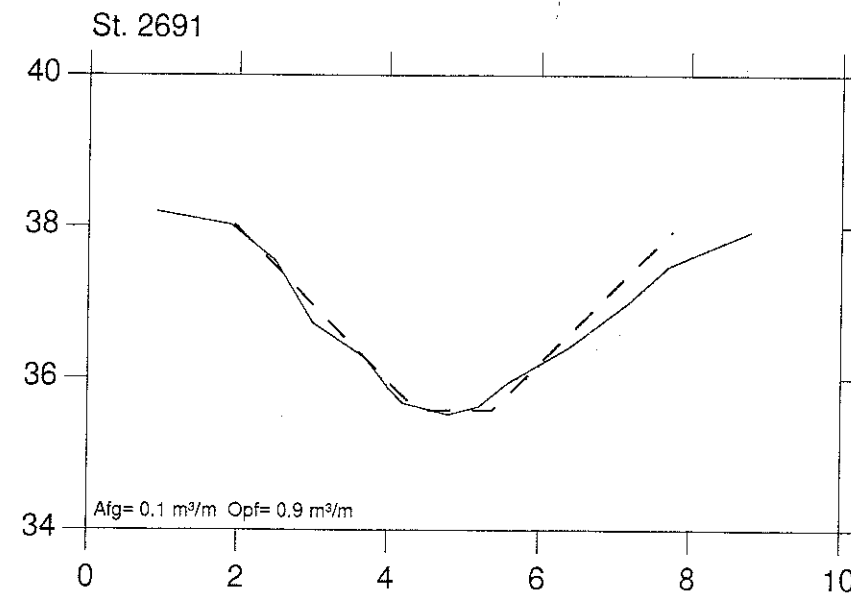
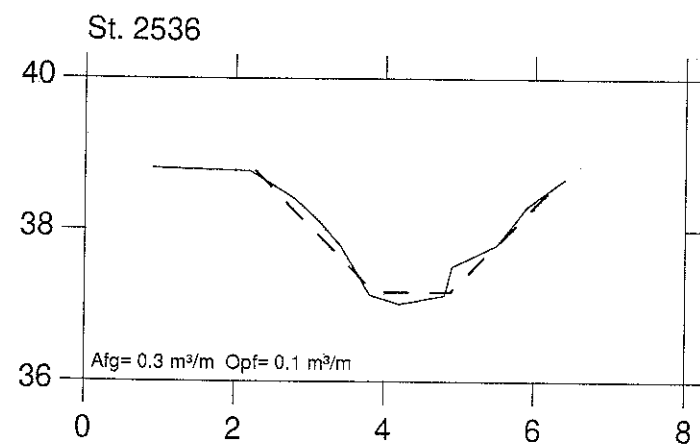
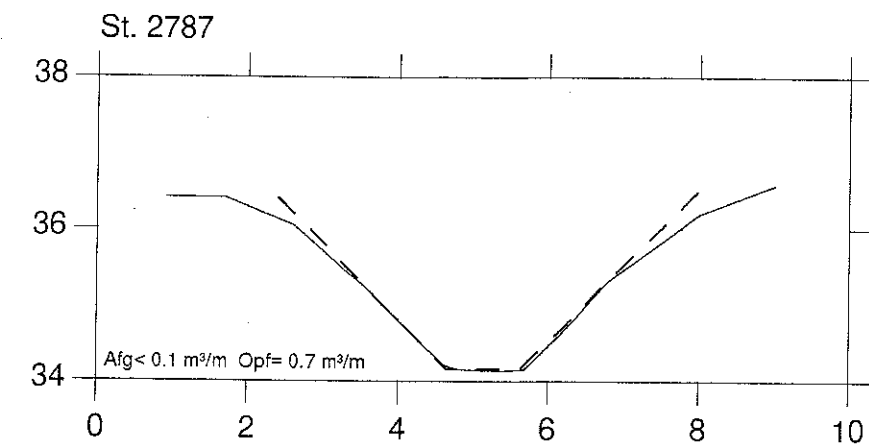
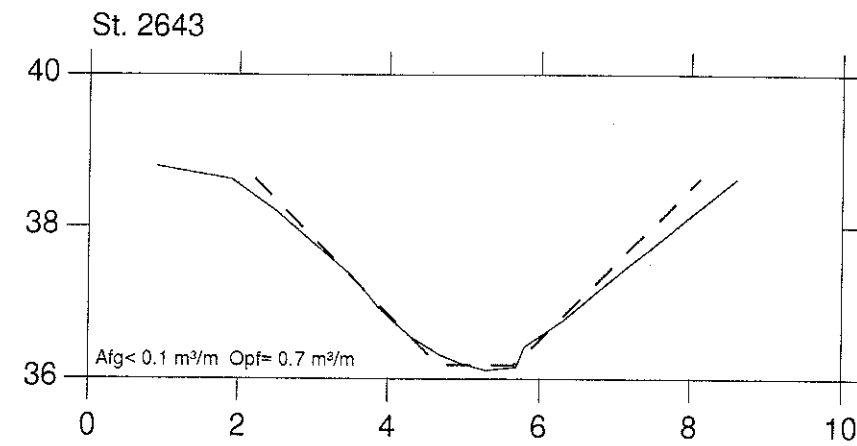
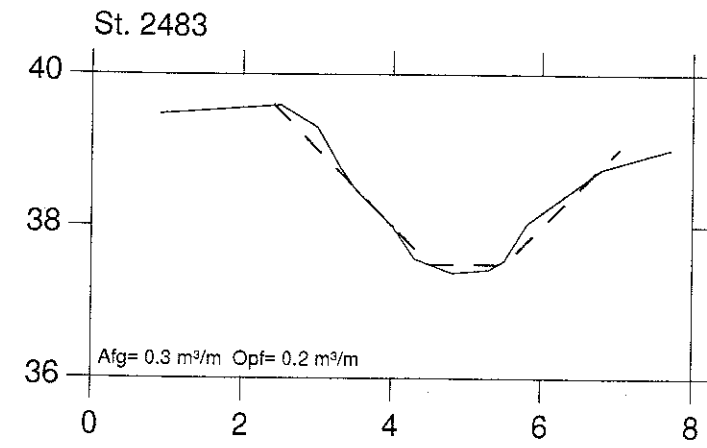

BØSTRUPRENDEN, HOVEDLØB

VASP 

Lodret akse : kote i m skala 1:100

—— Opmålt af Hedeselskabet 1989

Vandret akse : afstand i m skala 1:100

- - - - - Nyt regulativ

Hashøj Kommune

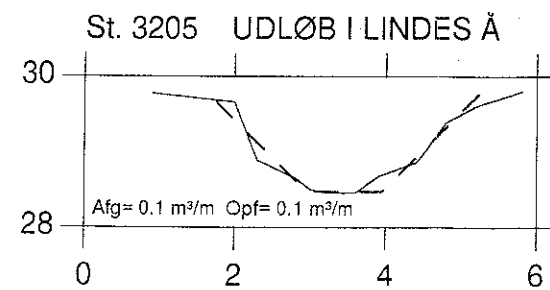
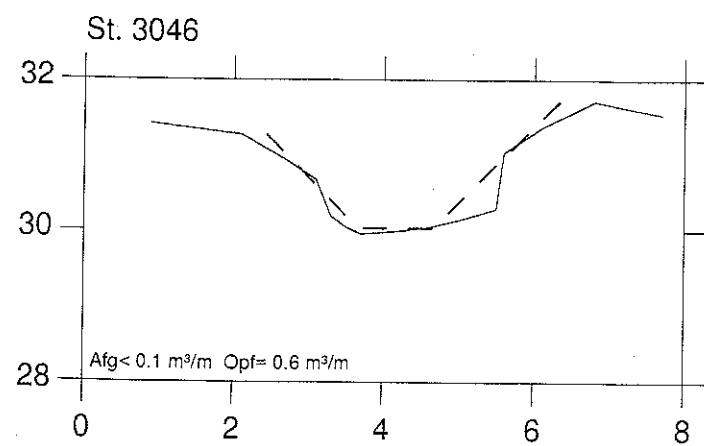
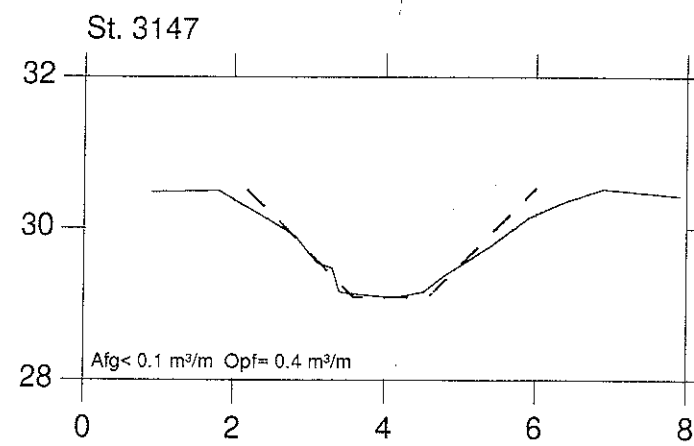
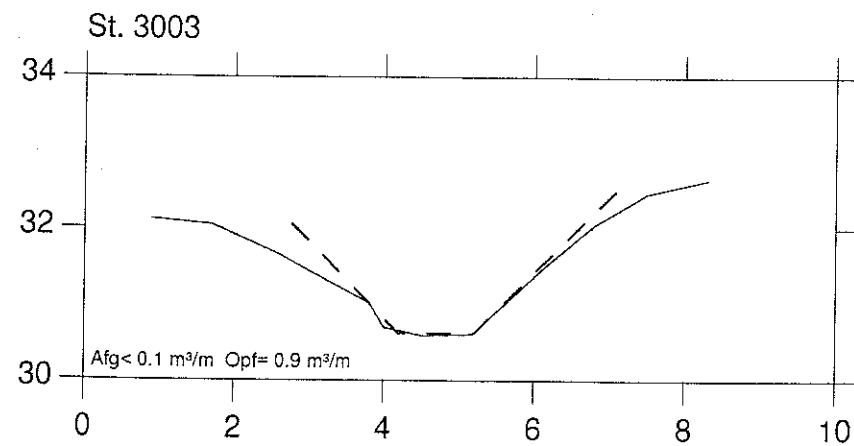
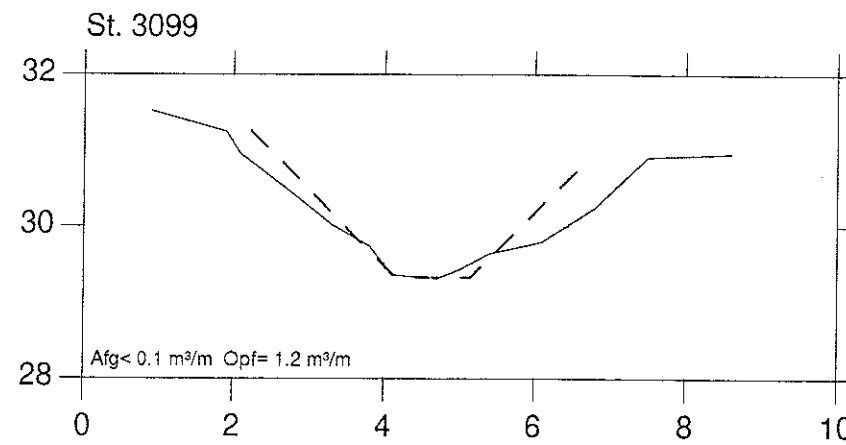
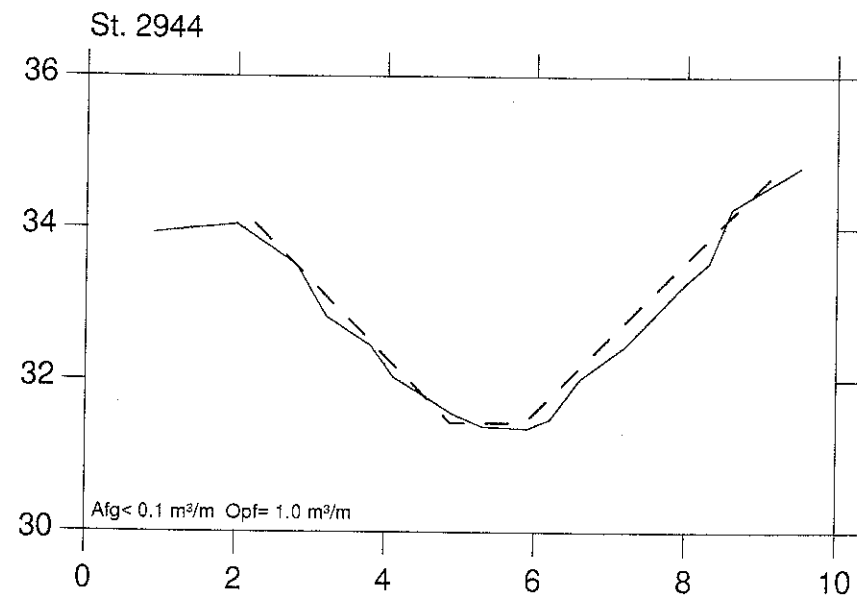

BØSTRUPRENDEN, SIDELØB 5BI

VASP 

Lodret akse : kote i m skala 1:100

— Opmålt af Hedeselskabet 1989

Vandret akse : afstand i m skala 1:100

- - - Nyt regulativ

Hashøj Kommune

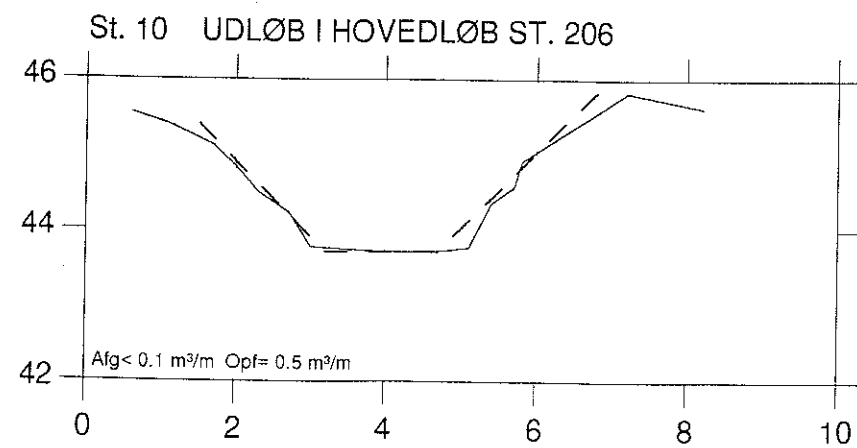
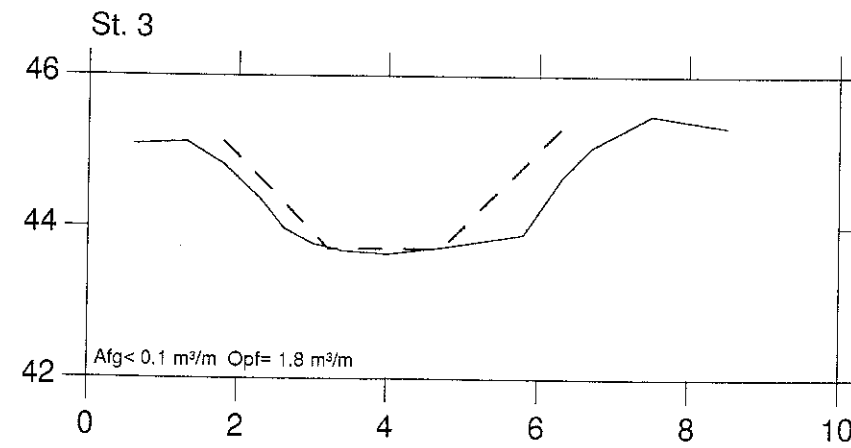
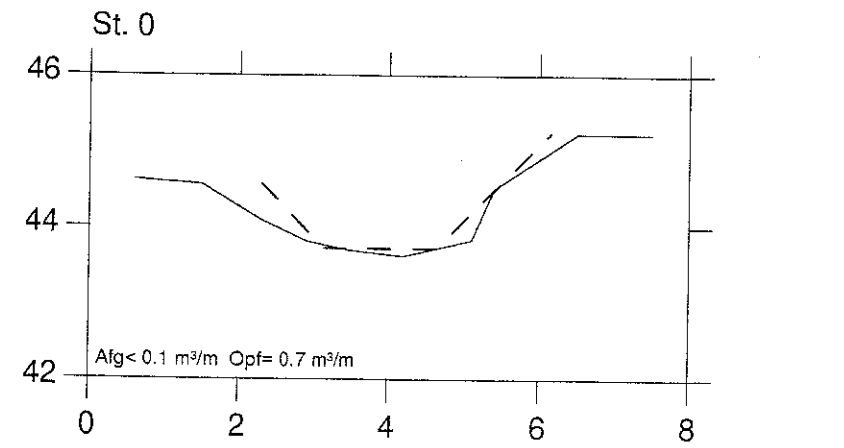

BØSTRUPRENDEN, SIDELØB 5BII

VASP 

Lodret akse : kote i m skala 1:100

— Opmålt af Hedeselskabet 1989

Vandret akse : afstand i m skala 1:100

- - - Nyt regulativ

Hashøj Kommune

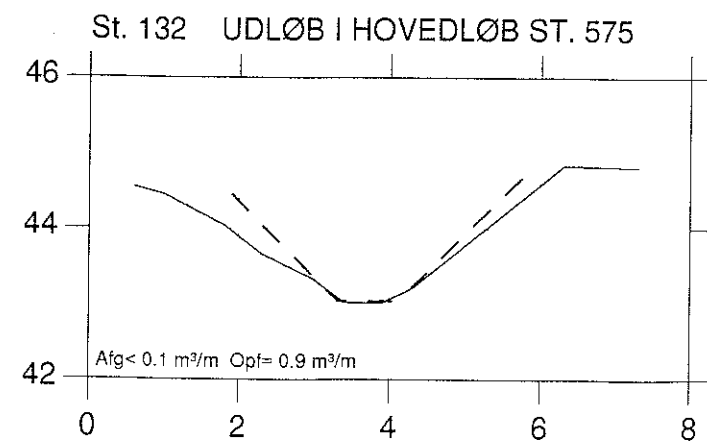
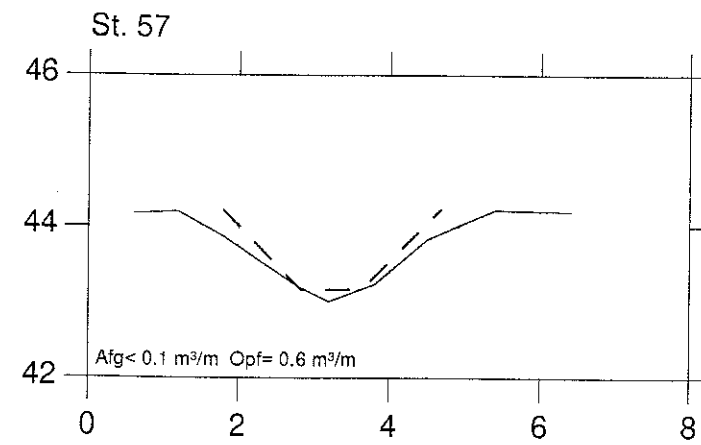
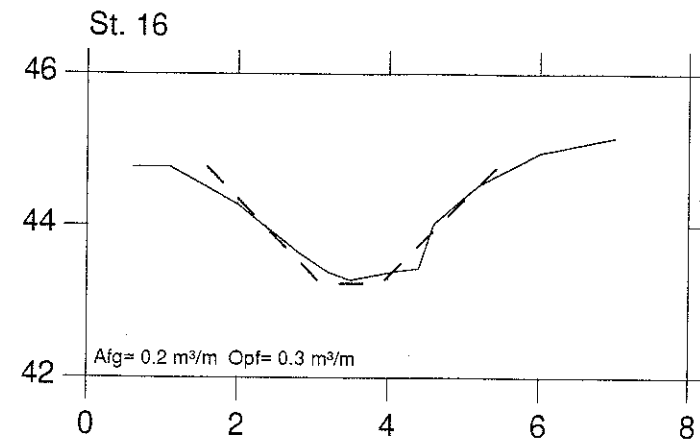

BØSTRUPRENDEN, SIDELØB 5BIII



VASP

Lodret akse : kote i m skala 1:100

— Opmålt af Hedeselskabet 1989

Vandret akse : afstand i m skala 1:100

- - - Nyt regulativ

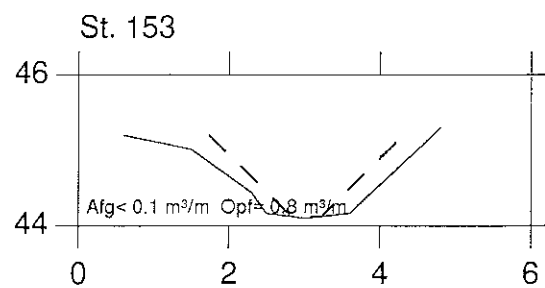
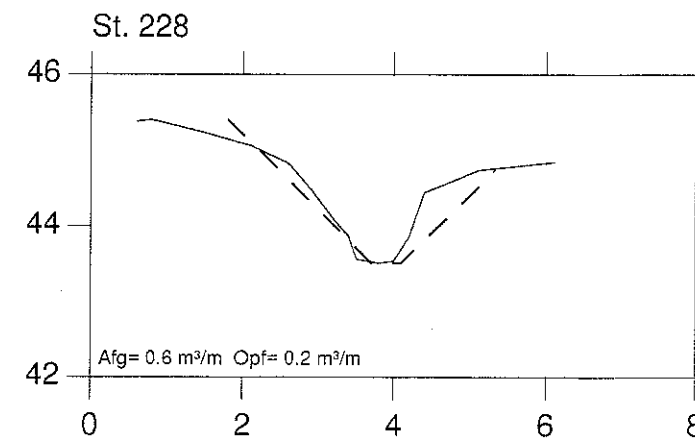
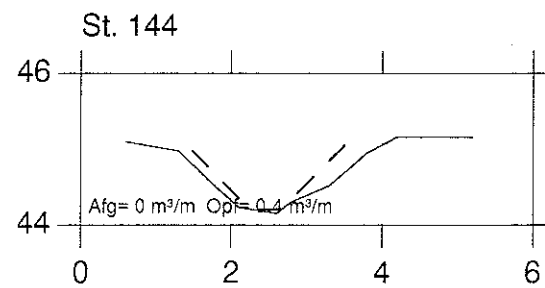
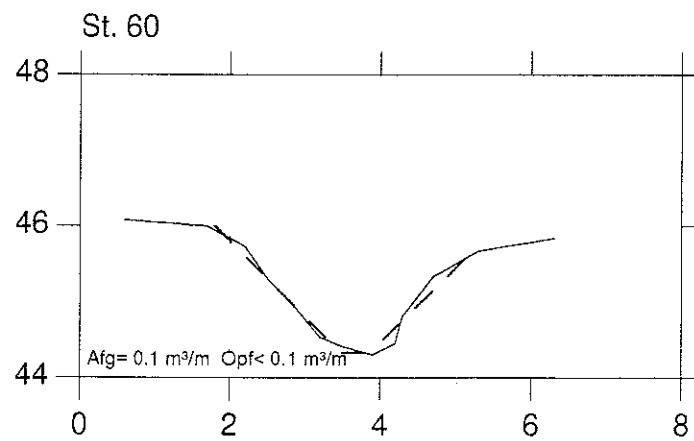
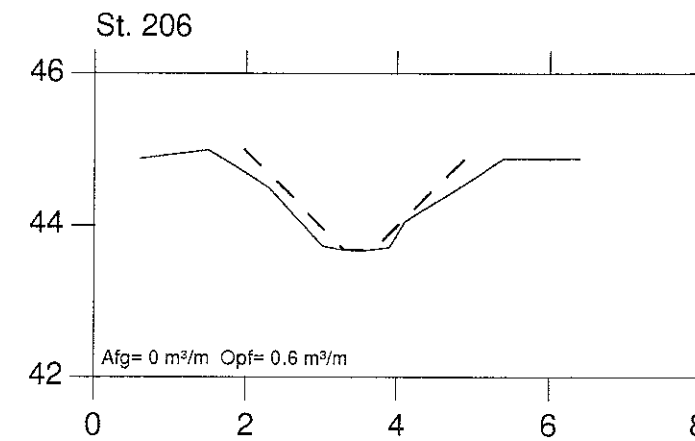
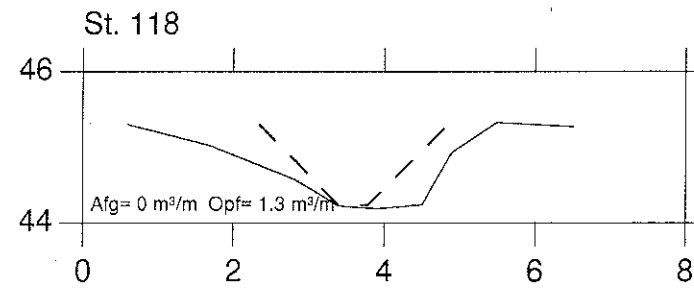
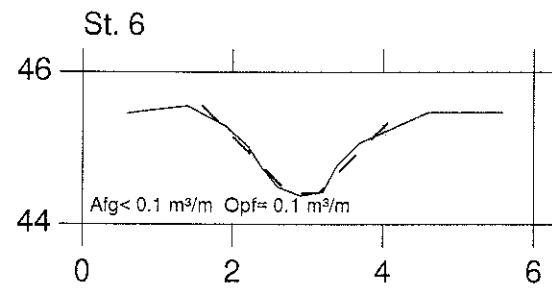
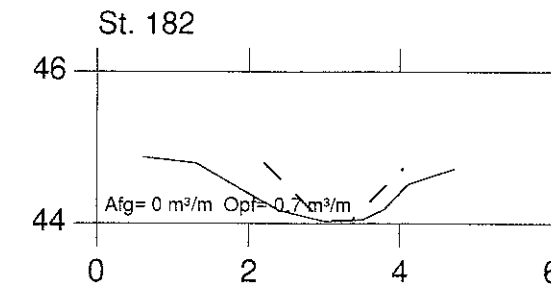
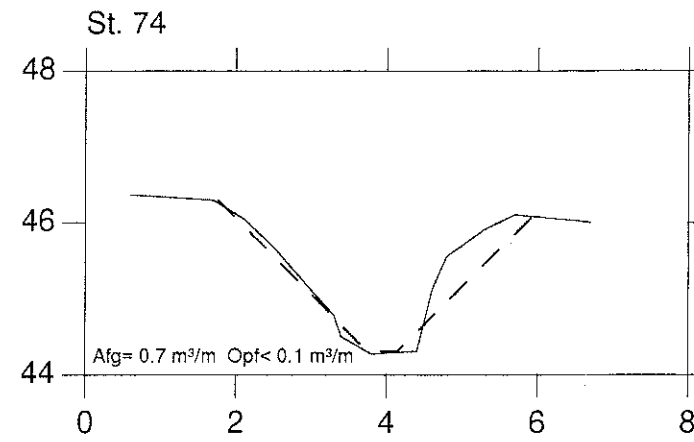
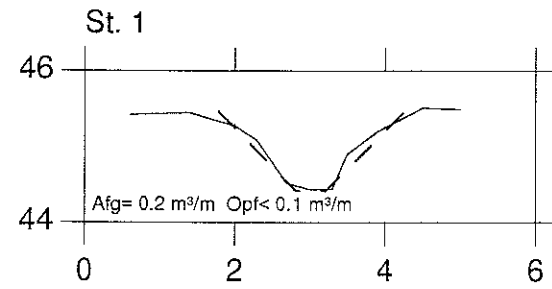

BØSTRUPRENDEN, SIDELØB 5BIII

VASP 

Lodret akse : kote i m skala 1:100

— Opmålt af Hedeselskabet 1989

Vandret akse : afstand i m skala 1:100

- - - Nyt regulativ

Hashøj Kommune

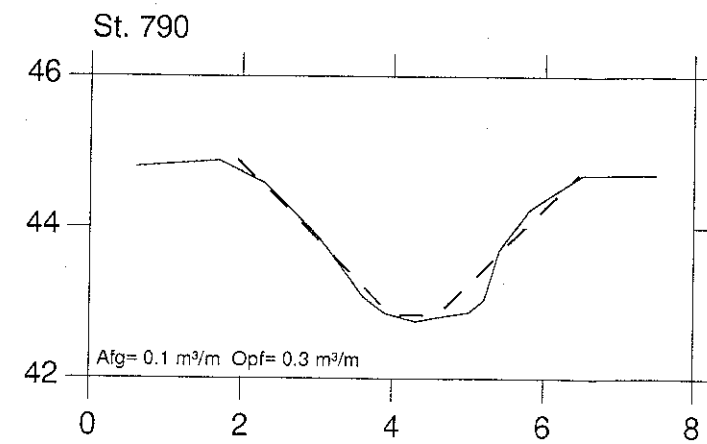
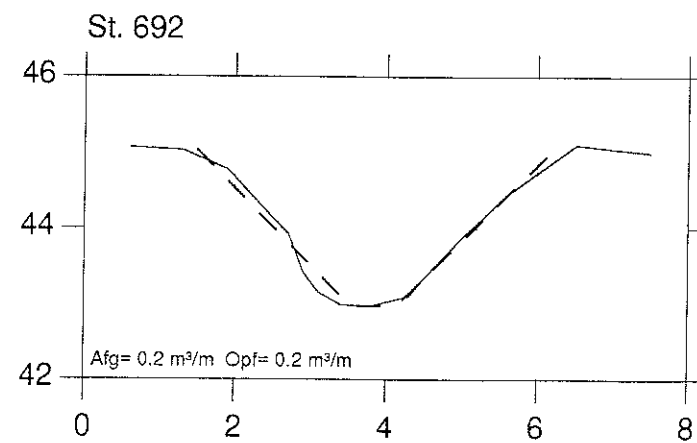
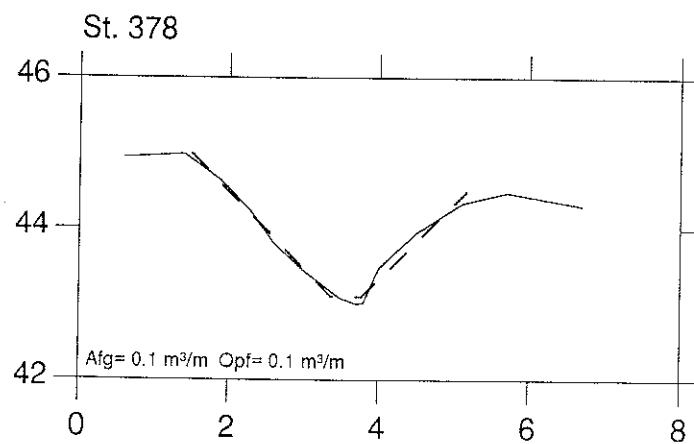
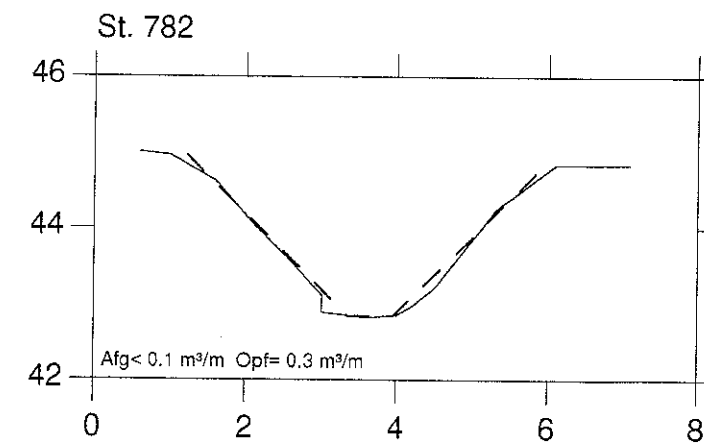
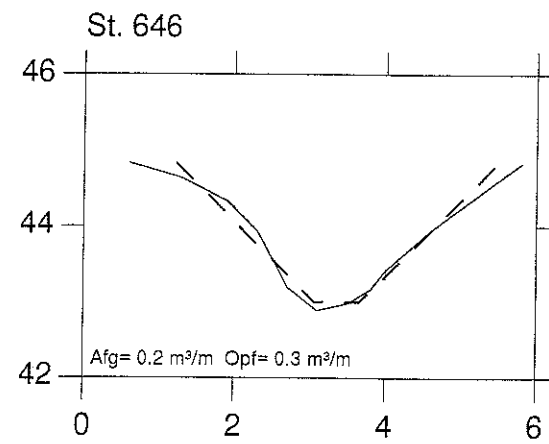
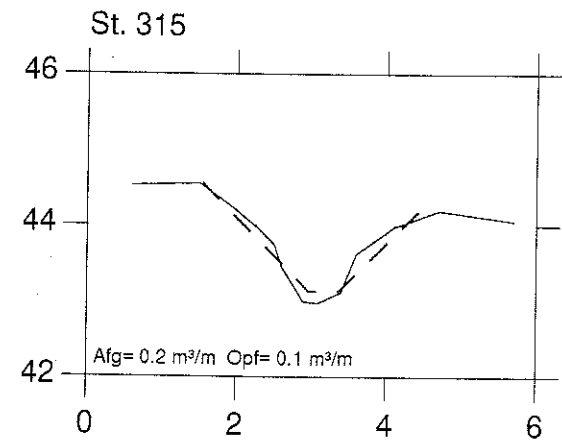
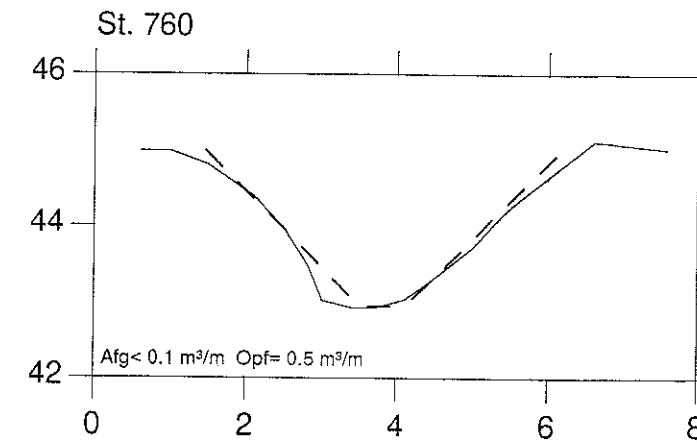
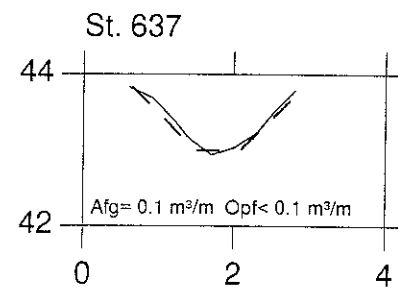
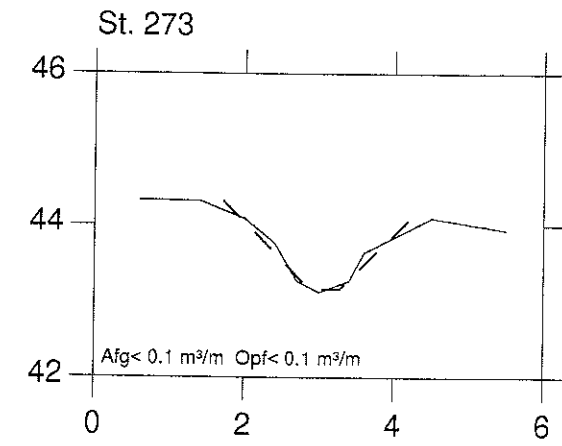

BØSTRUPRENDEN, SIDELØB 5BIII

VASP 

Lodret akse : kote i m skala 1:100

— Opmålt af Hedeselskabet 1989

Vandret akse : afstand i m skala 1:100

- - - Nyt regulativ

Hashøj Kommune

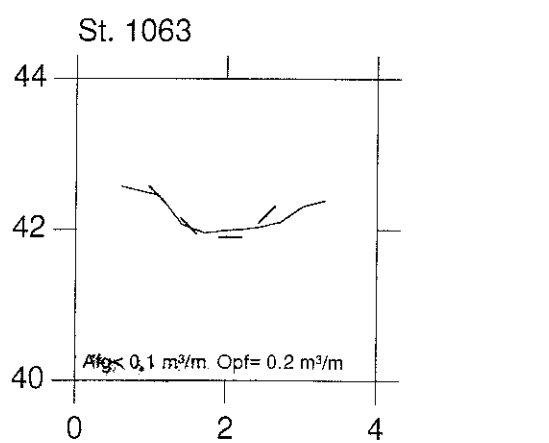
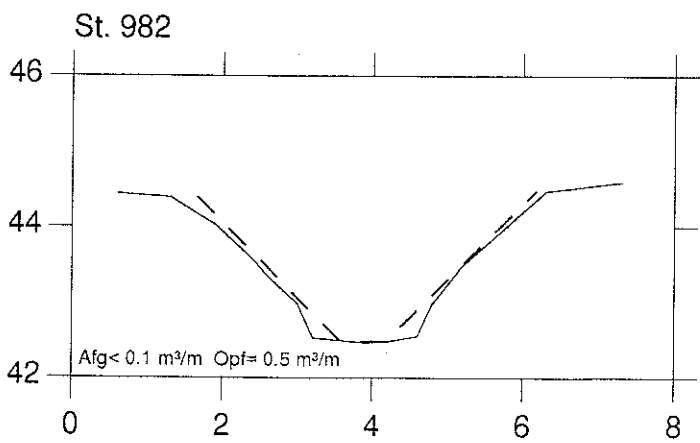
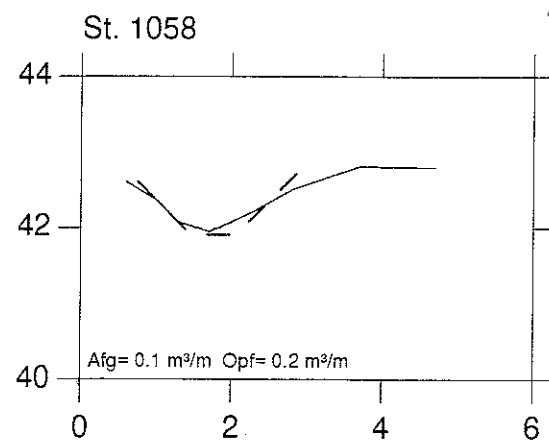
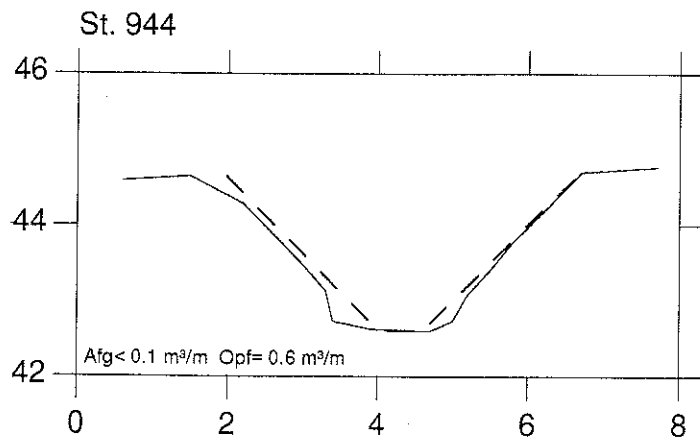
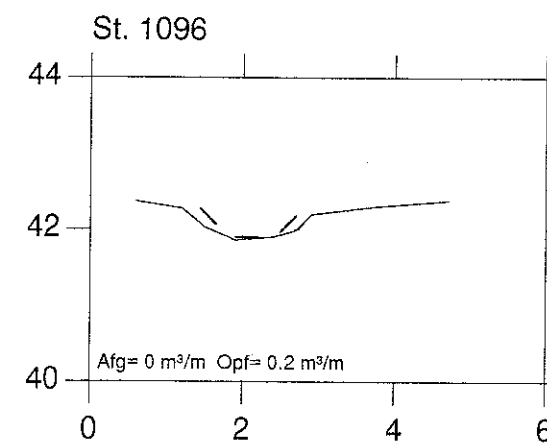
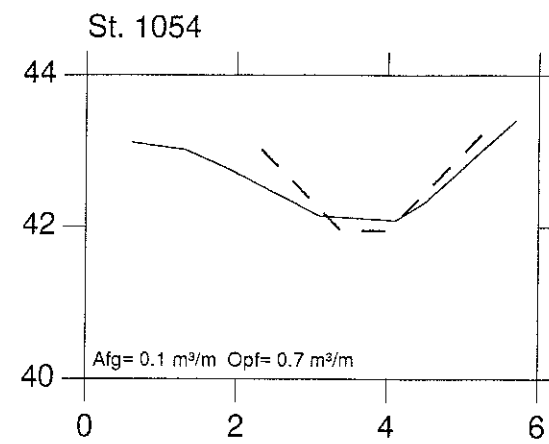
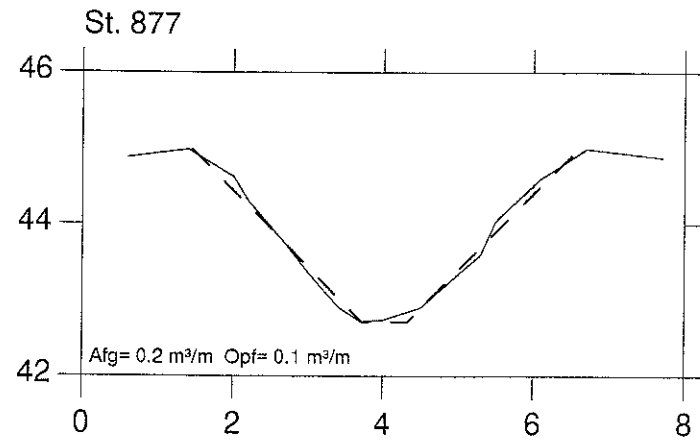

BØSTRUPRENDEN, SIDELØB 5BIIIa

VASP 

Lodret akse : kote i m skala 1:100

— Opmålt af Hedeselskabet 1989

Vandret akse : afstand i m skala 1:100

- - - Nyt regulativ

Hashøj Kommune

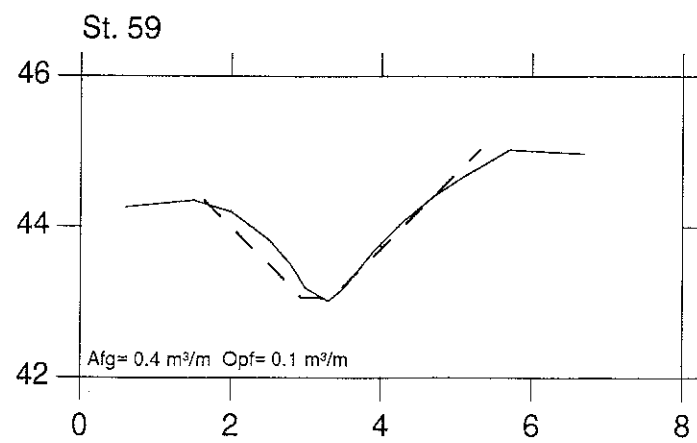
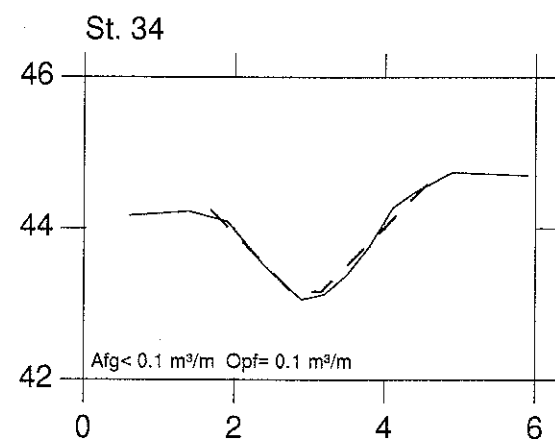
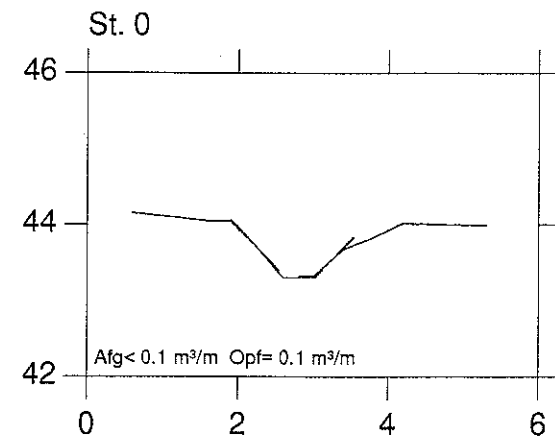

BØSTRUPRENDEN, SIDELØB 5BIV

VASP

Lodret akse : kote i m skala 1:100
Vandret akse : afstand i m skala 1:100

— Opmålt af Hedesleskabet 1989
- - - Nyt regulativ

Hashøj Kommune

