

# Gammel-lungrenden

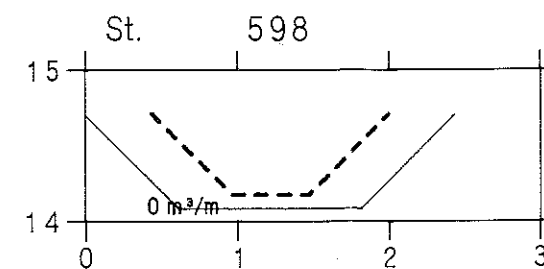

— Opmålt af DDH Roskilde aug 1994  
 - - - - - Nyt regulativ

lodret akse : kote i m skala 1:50  
 vandret akse : afstand i m skala 1:50

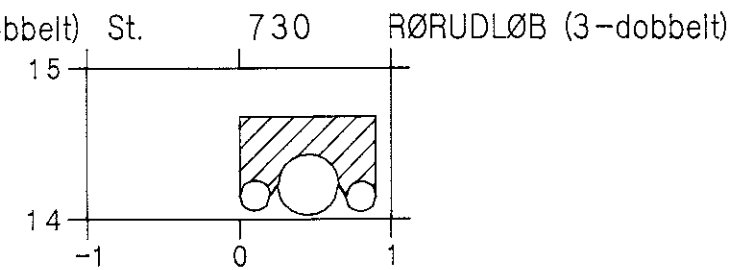
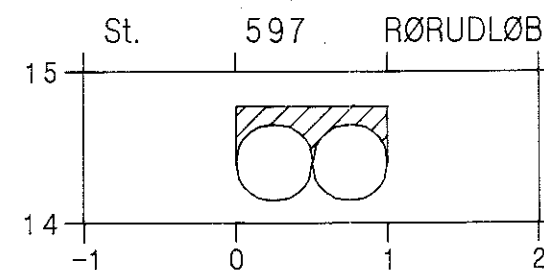
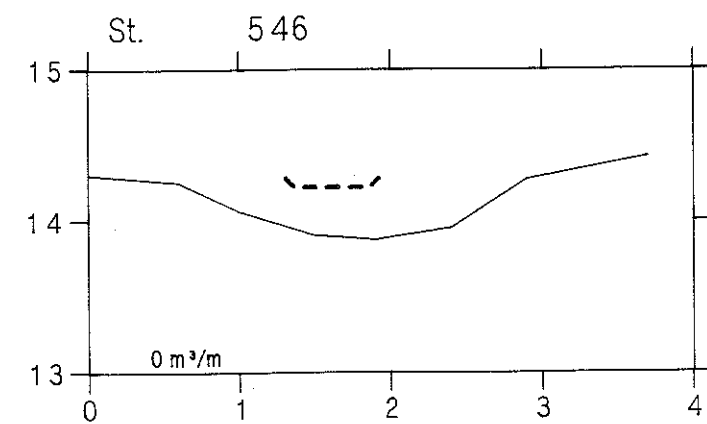
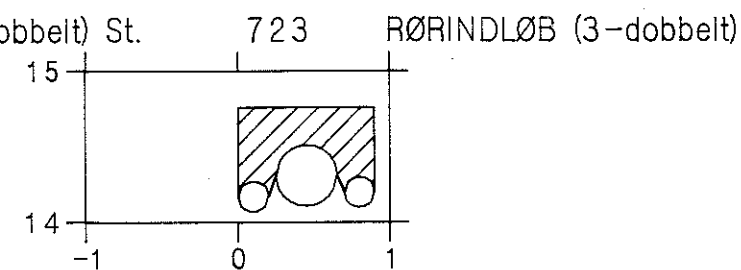
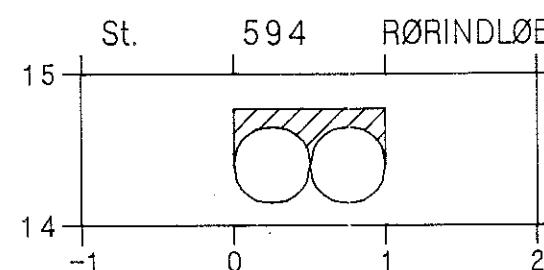
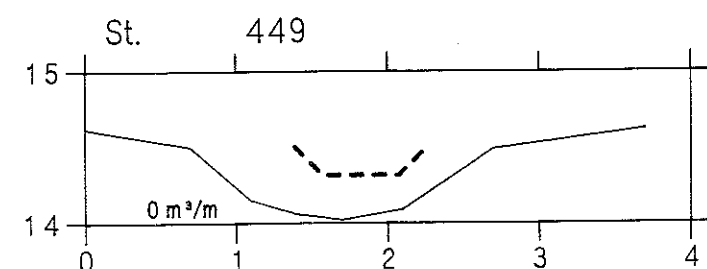
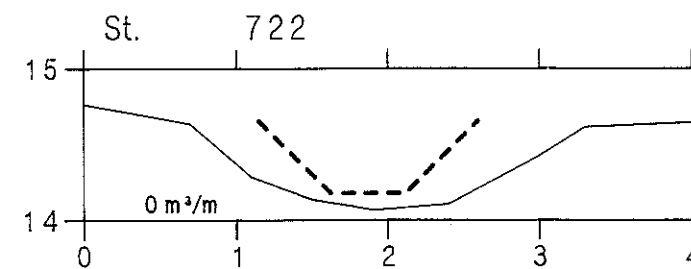
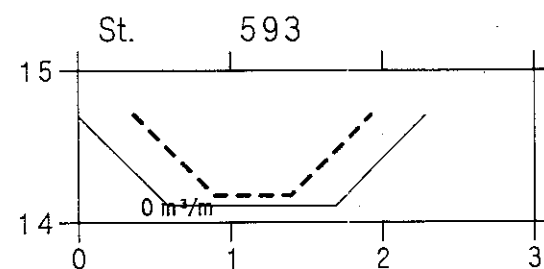
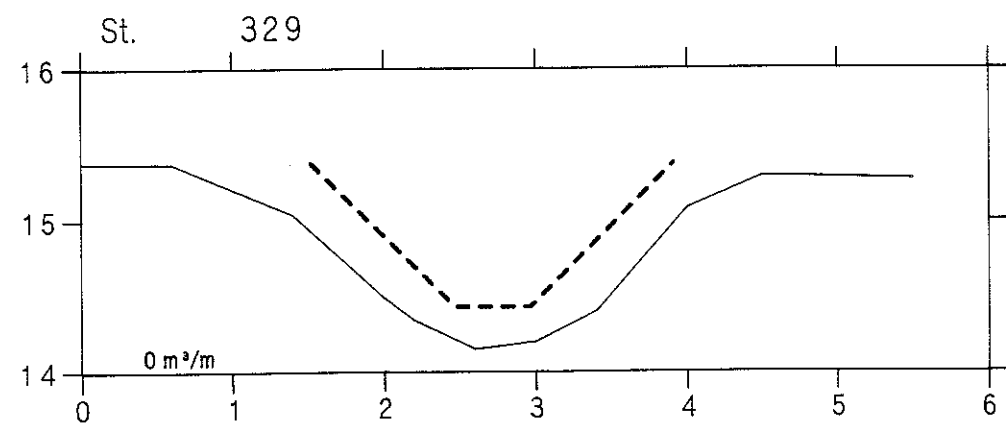

# Gammel-lungrenden

VASP 

— Opmålt af DDH Roskilde aug 1994

- - - - - Nyt regulativ

lodret akse : kote i m skala 1:50  
 vandret akse : afstand i m skala 1:50

HEDESELSKABET 

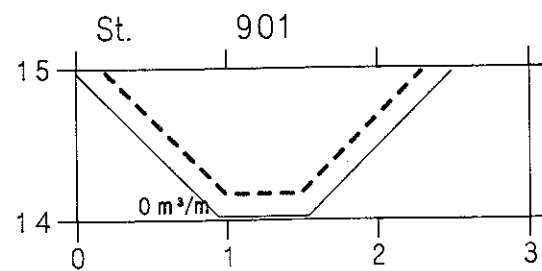
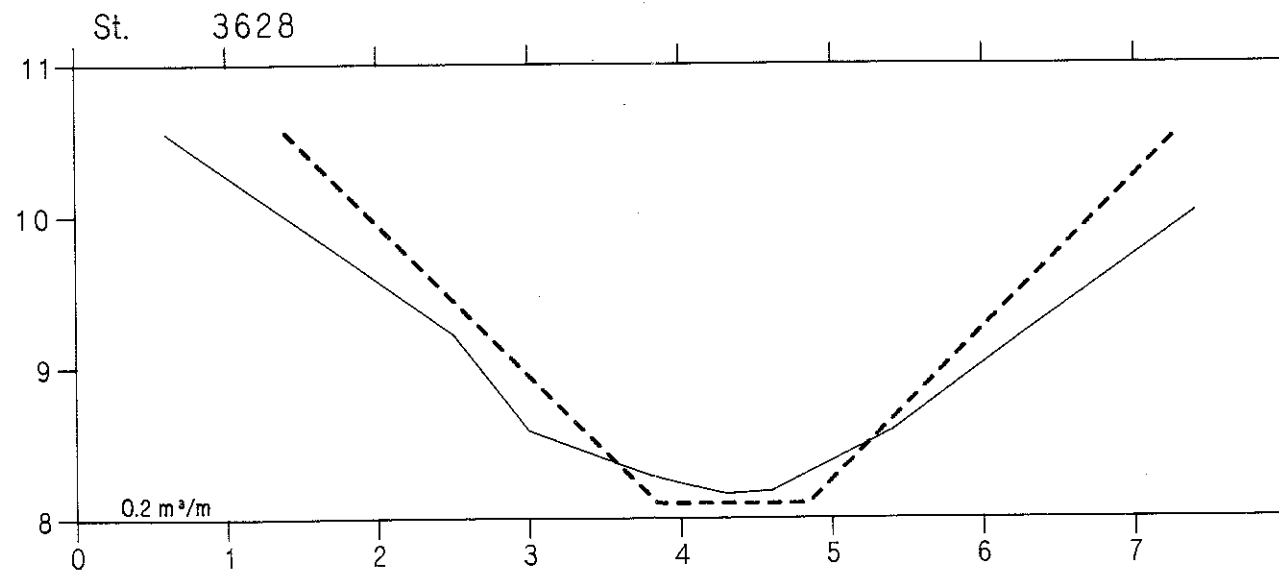
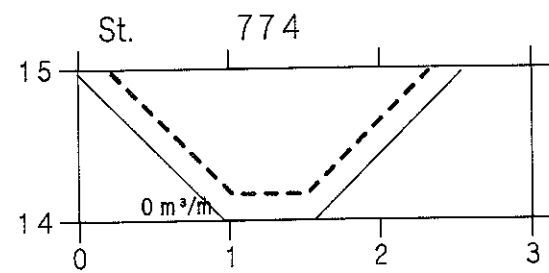
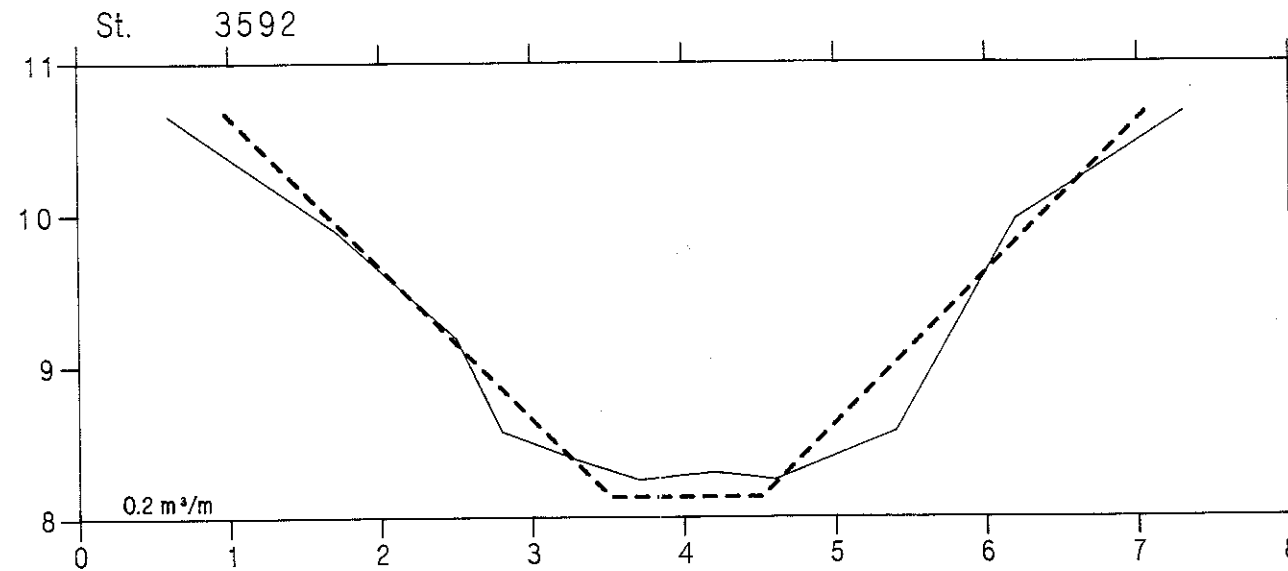
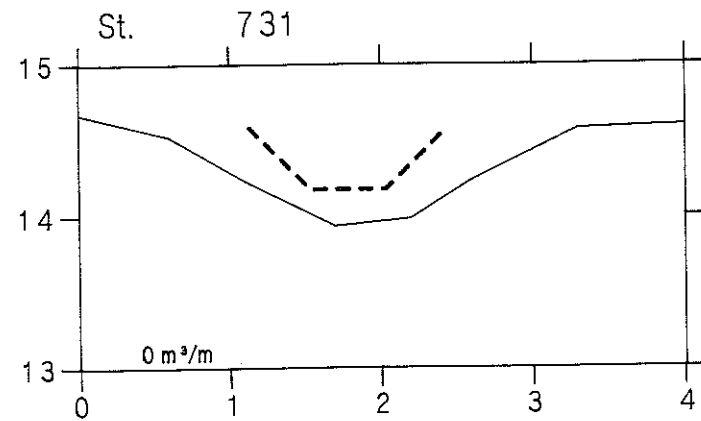

# Gammel-lungrenden

VASP 

— Opmålt af DDH Roskilde aug 1994

- - - - - Nyt regulativ

lodret akse : kote i m skala 1:50  
vandret akse : afstand i m skala 1:50

HEDESELSKABET 

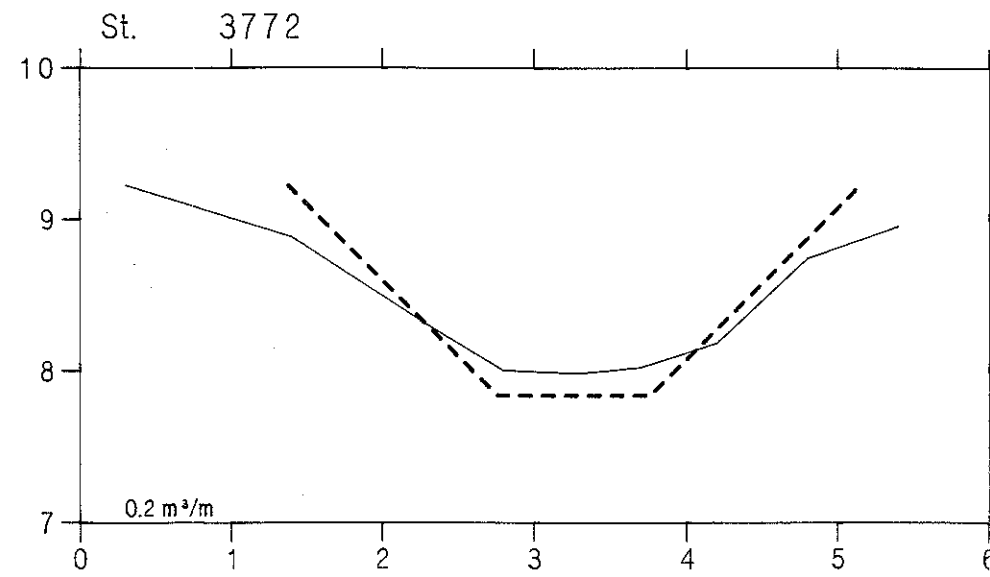
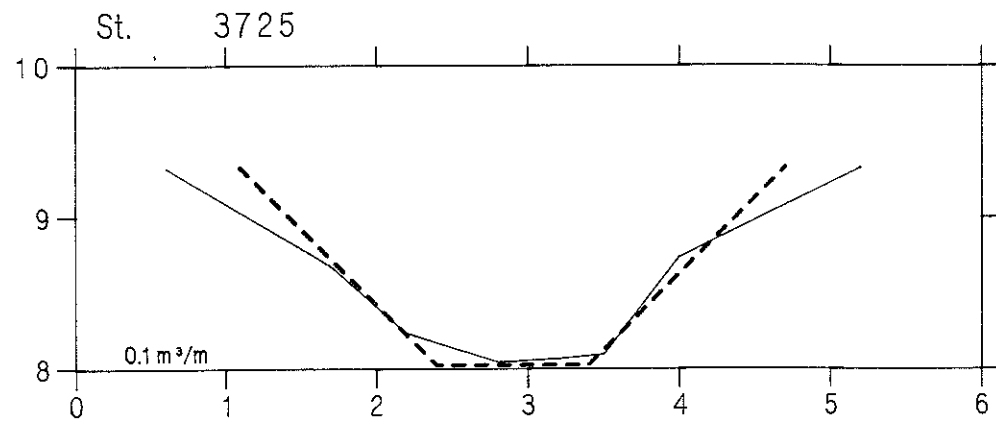
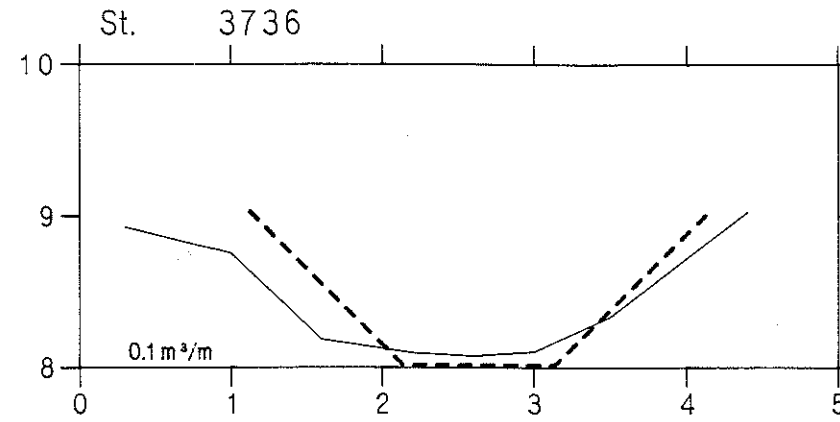
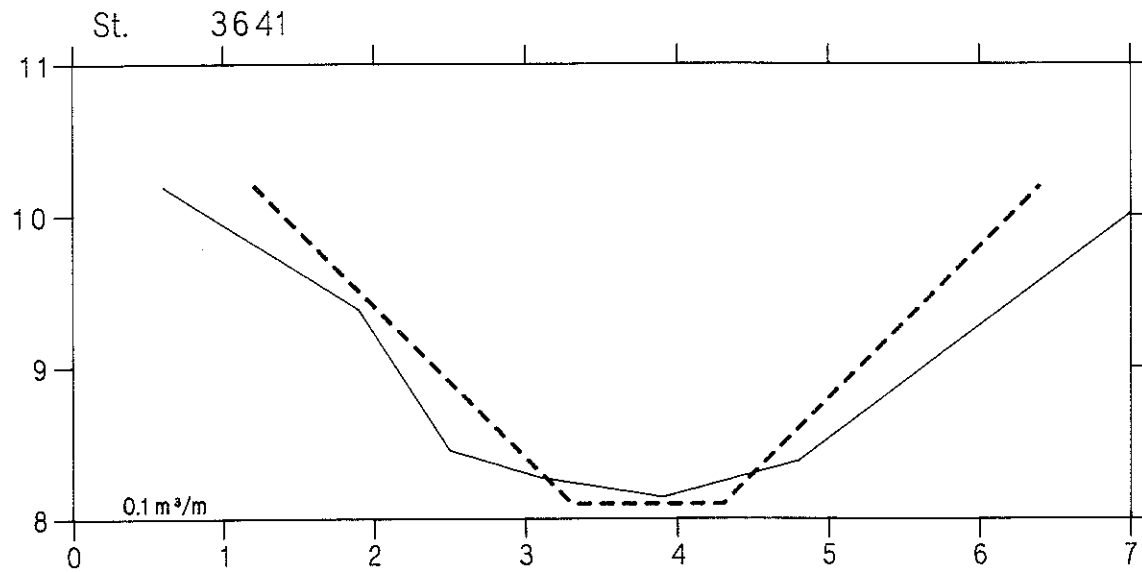

# Gammel-lungrenden

VASP 

— Opmålt af DDH Roskilde aug 1994

- - - - - Nyt regulativ

lodret akse : kote i m skala 1:50

vandret akse : afstand i m skala 1:50

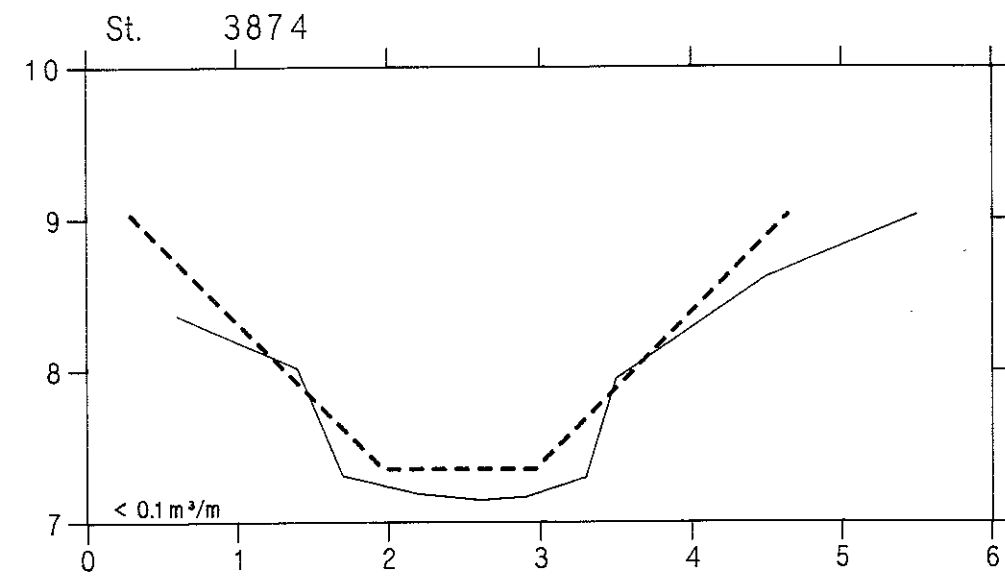

# Gerdruprenden

VASP 

— Opmålt af DDH Roskilde dec. 1995

- - - - - Nyt regulativ

Iodret akse : kote i m skala 1:100

vandret akse : afstand i m skala 1:100

HEDESELSKABET

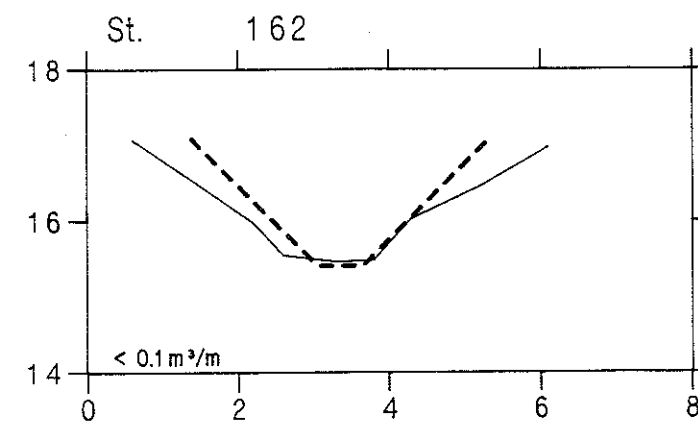
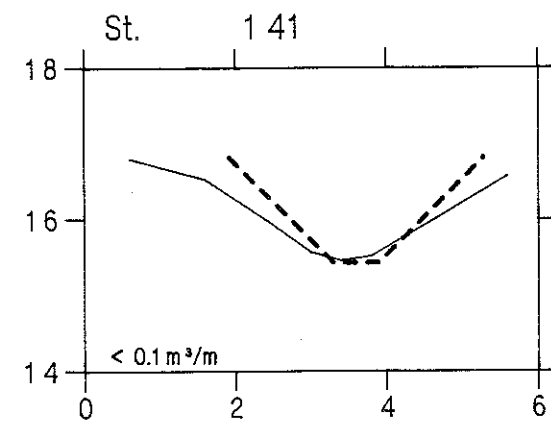
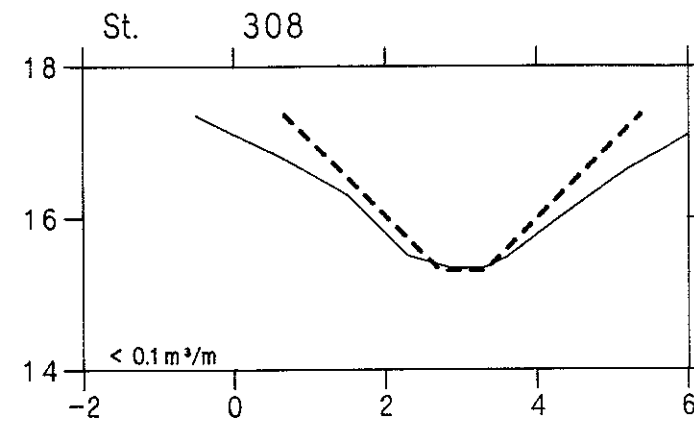
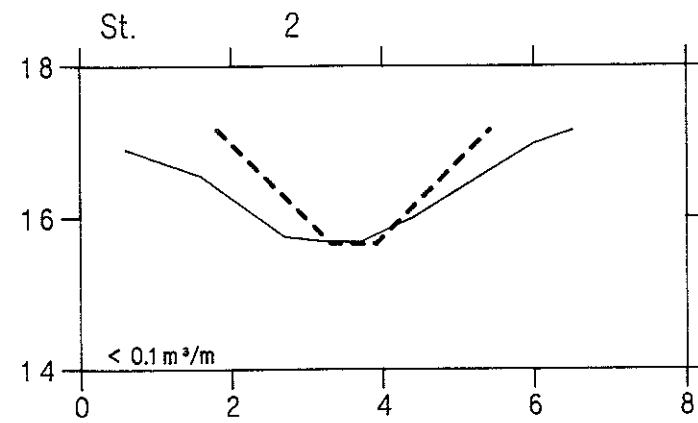

# Tilløb nr. 7d.

VASP 

HEDESELSKABET 

— Opmåling af DDH/Roskilde aug. 1994

- - - - - Nyt regulativ

lodret akse : kote i m skala 1:100  
vandret akse : afstand i m skala 1:100

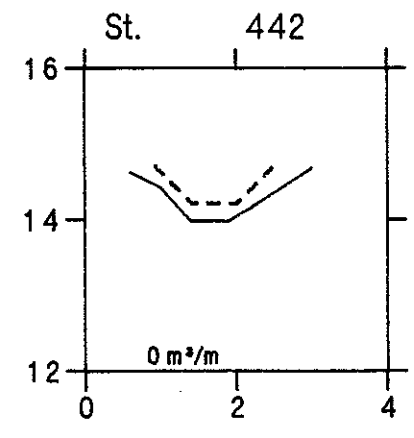
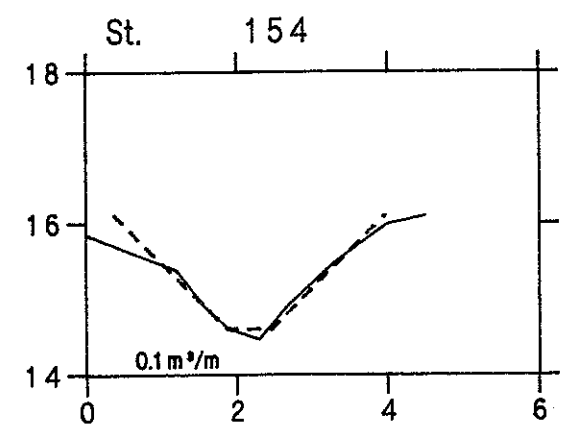
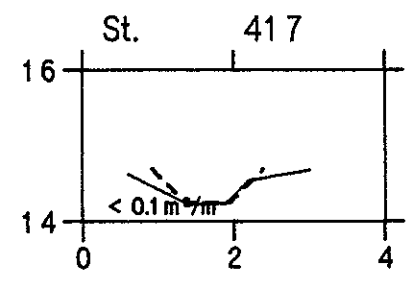
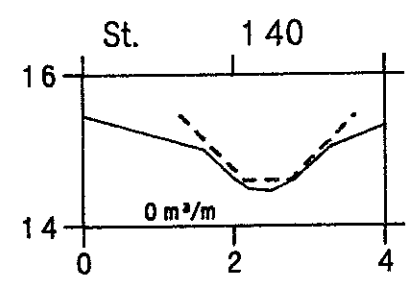
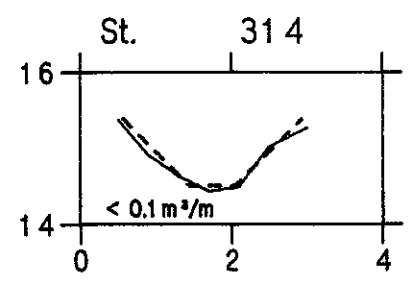
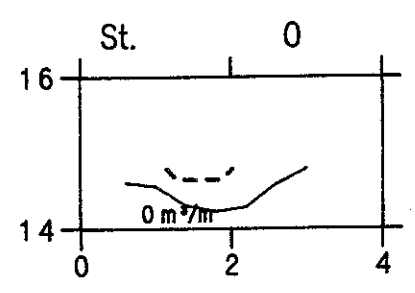

# Tilløb nr. 7e.

VASP 

—— Opmålt af DDH/Roskilde aug. 1994

----- Nyt regulativ

lodret akse : kote i m skala 1:50

vandret akse : afstand i m skala 1:50

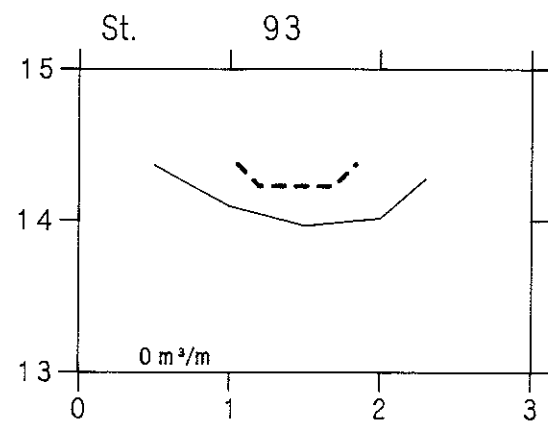
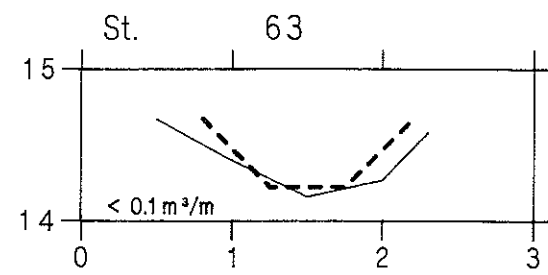

HEDESELSKABET 