

# Marbækrenden

VASP 

— Opmåling foretaget af DDH/Slagelse 1989

- - - - - Nyt regulativ

lodret akse : kote i m skala 1:100

vandret akse : afstand i m skala 1:100

HEDESELSKABET 

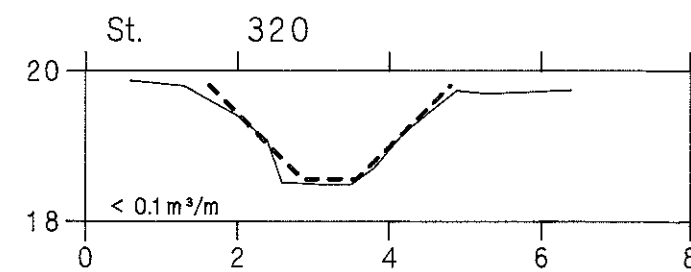
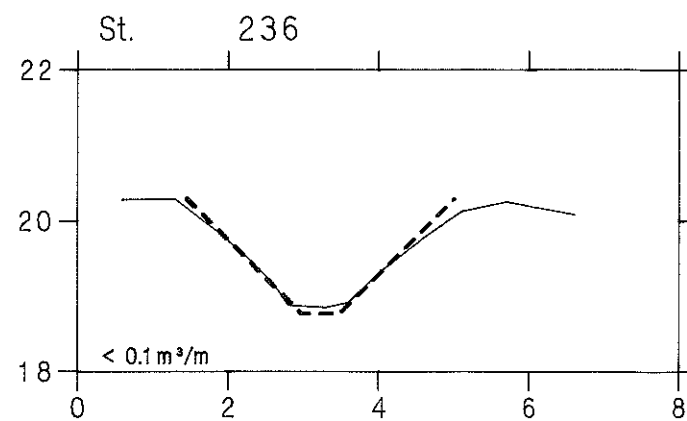
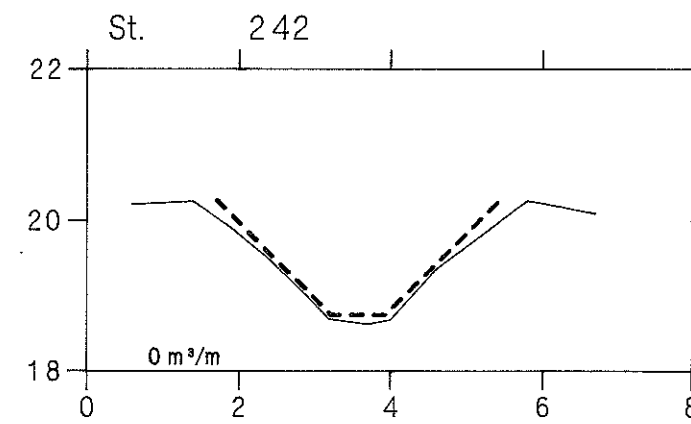
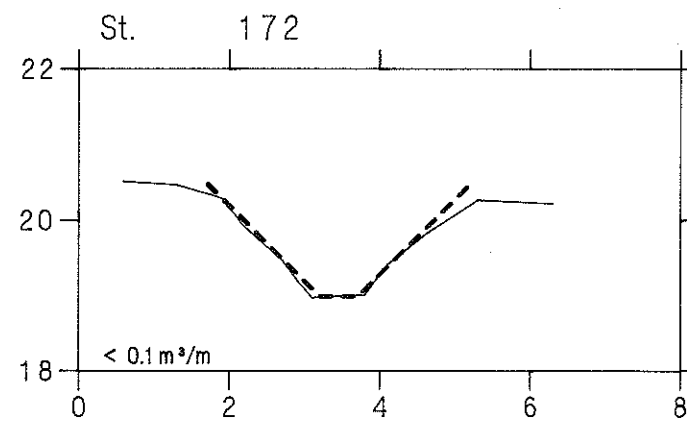
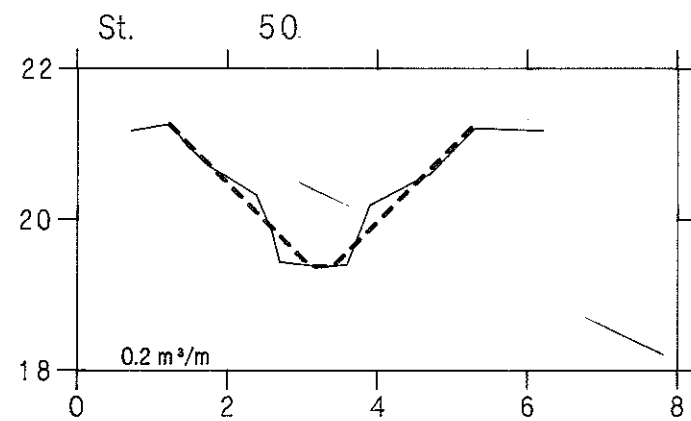
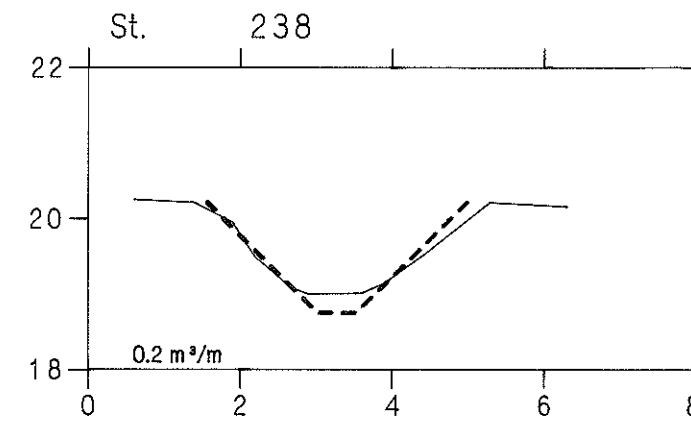
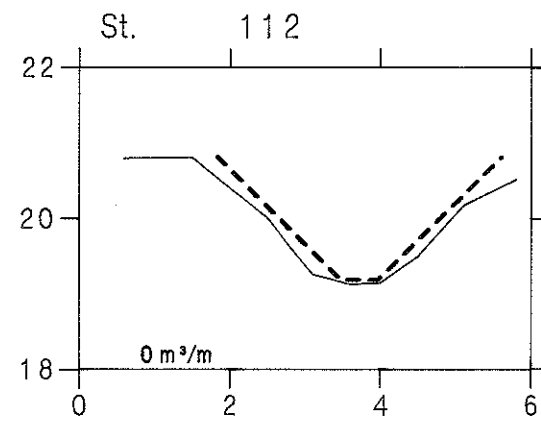
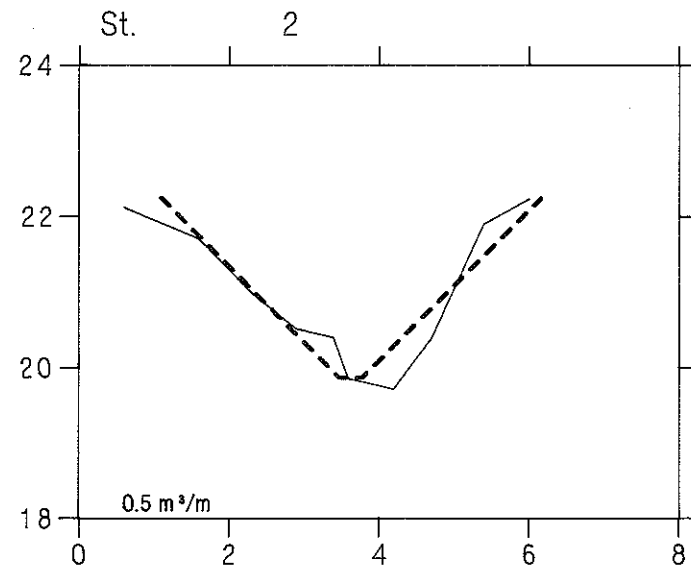

# Marbækrenden

VASP 

HEDESELSKABET 

— Opmåling foretaget af DDH/Slagelse 1989

- - - - - Nyt regulativ

lodret akse : kote i m skala 1:100

vandret akse : afstand i m skala 1:100

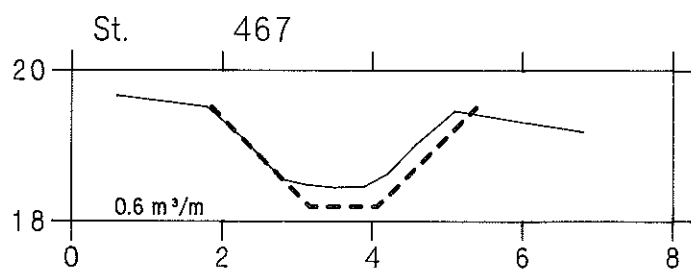
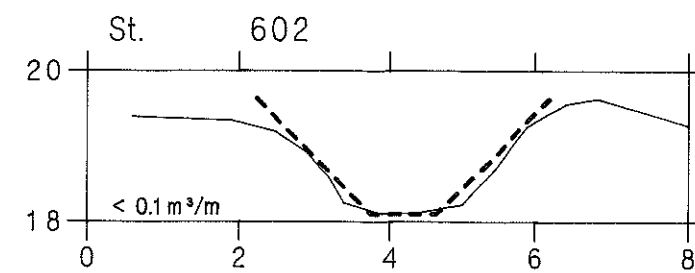
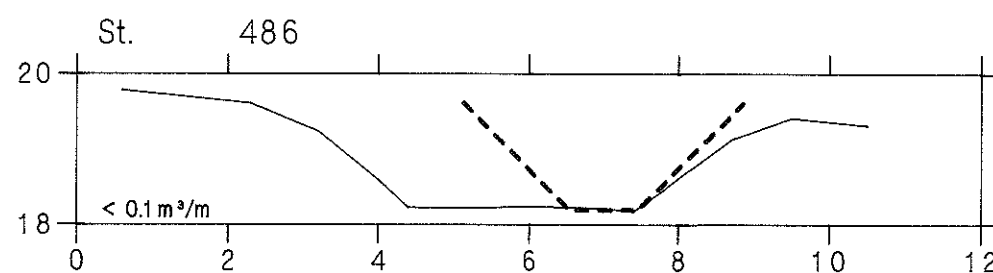
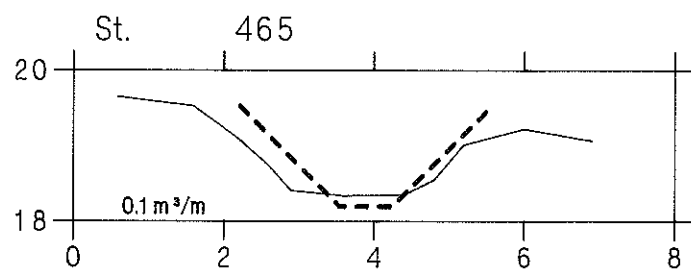
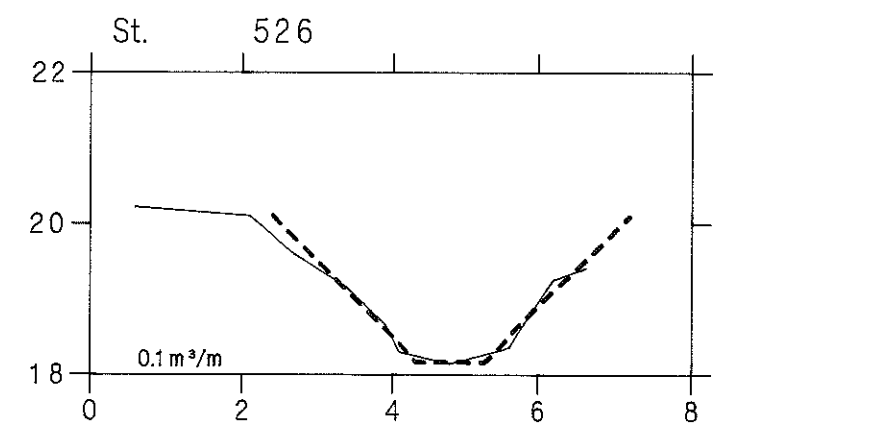
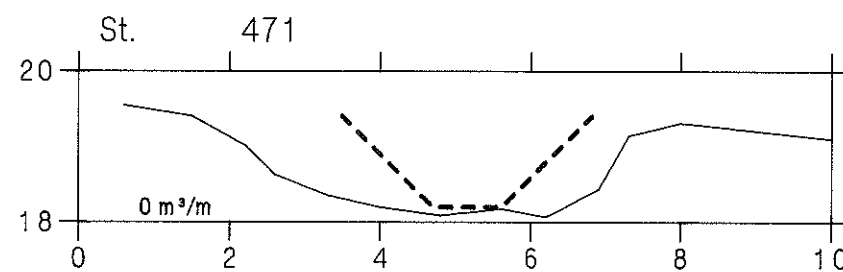
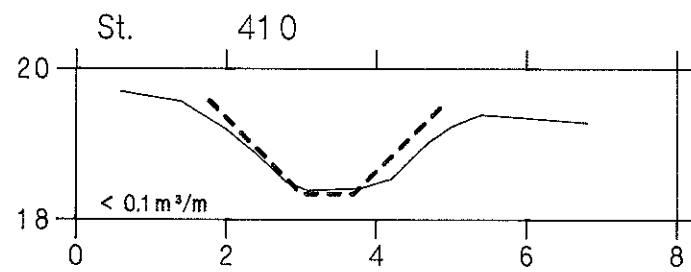
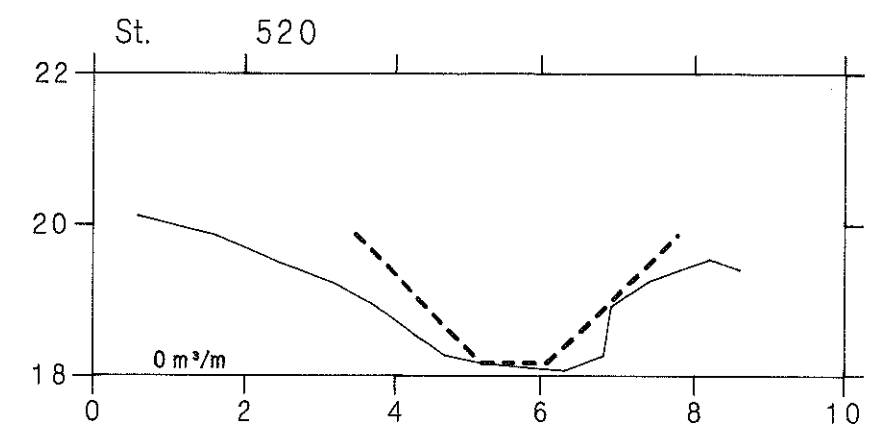
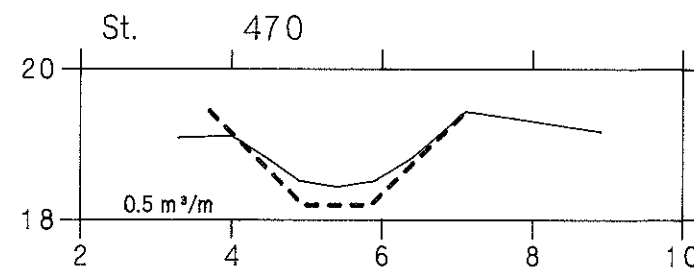
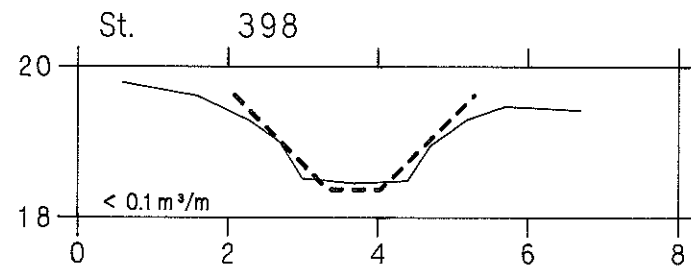

# Marbækrenden

VASP 

HEDESELSKABET 

— Opmåling foretaget af DDH/Slagelse 1989

- - - - - Nyt regulativ

Iodret akse : kote i m skala 1:100

Vandret akse : afstand i m skala 1:100

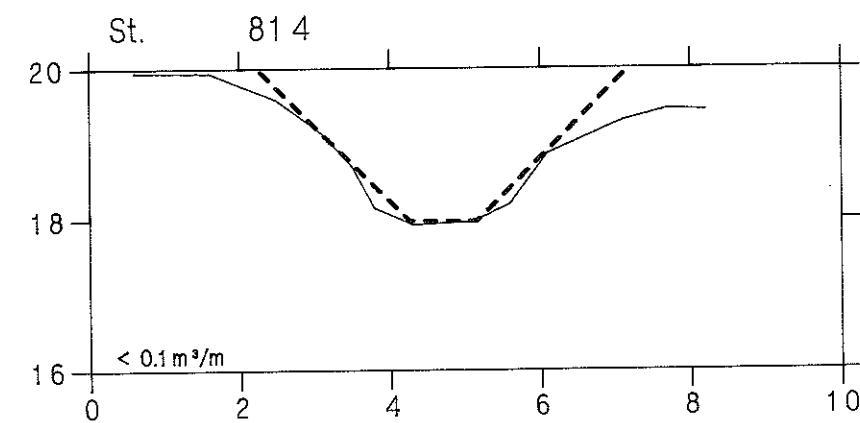
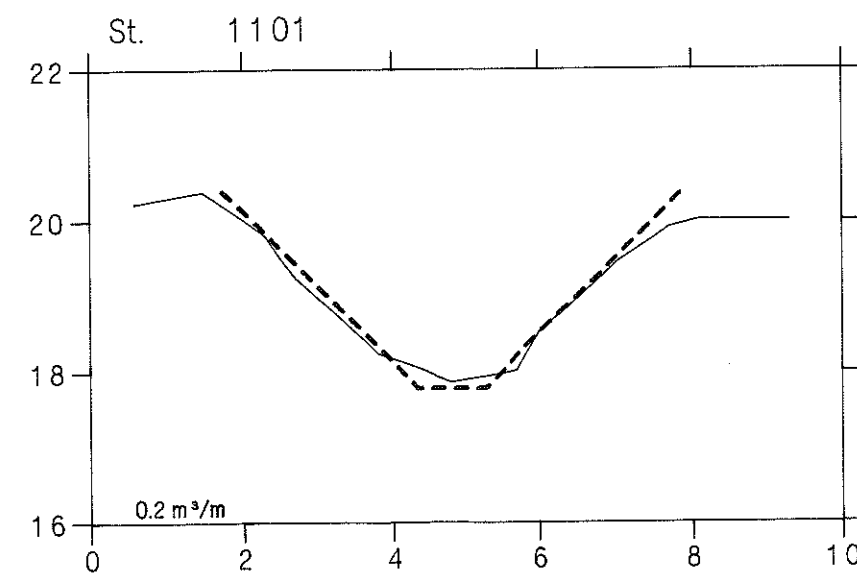
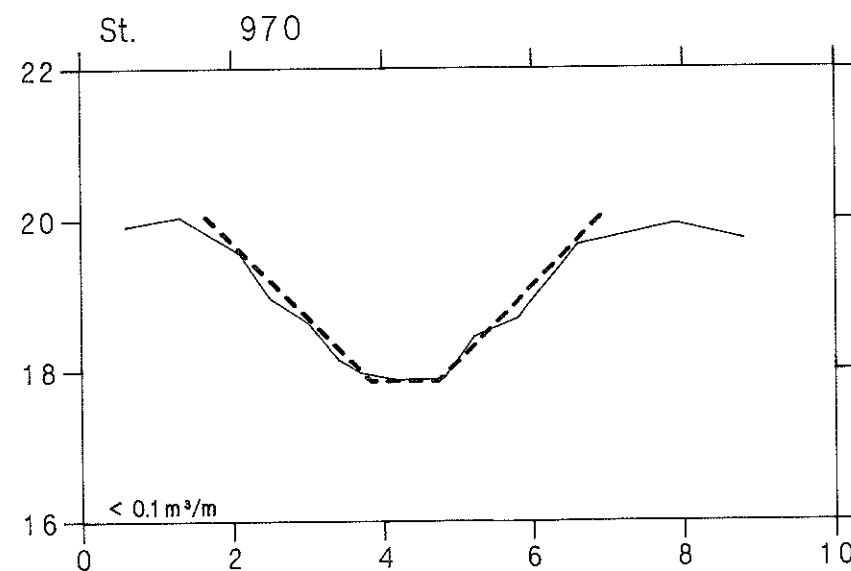
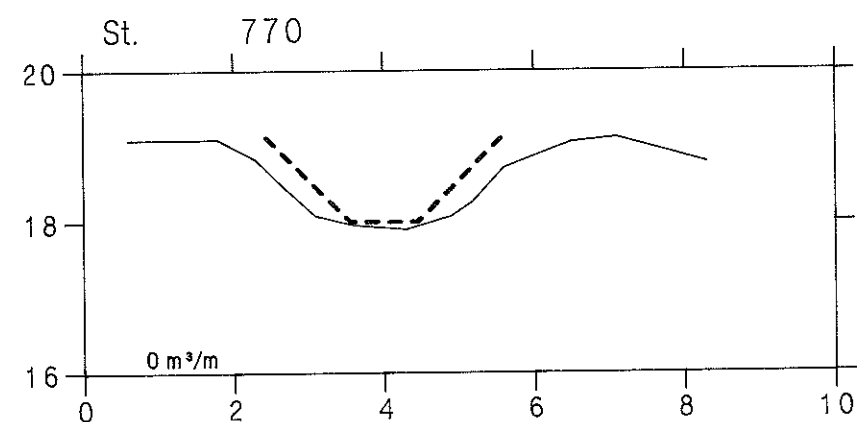
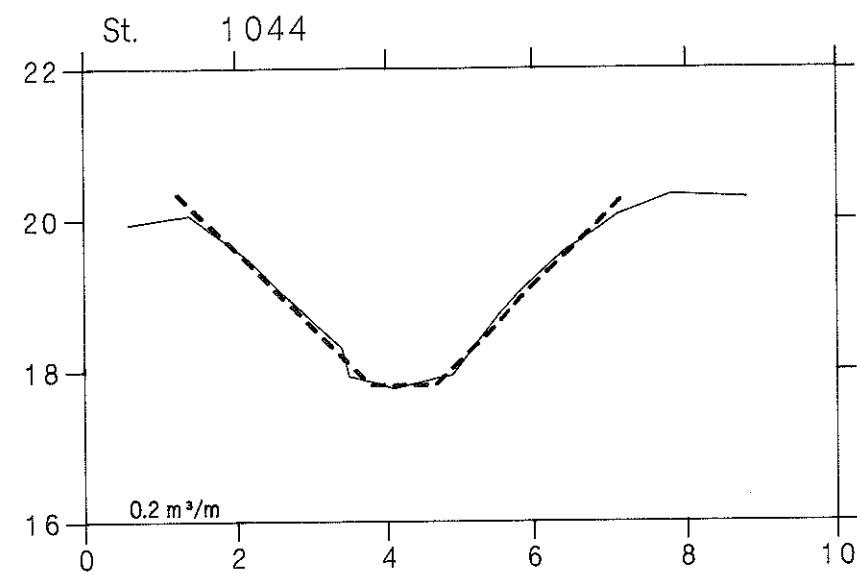
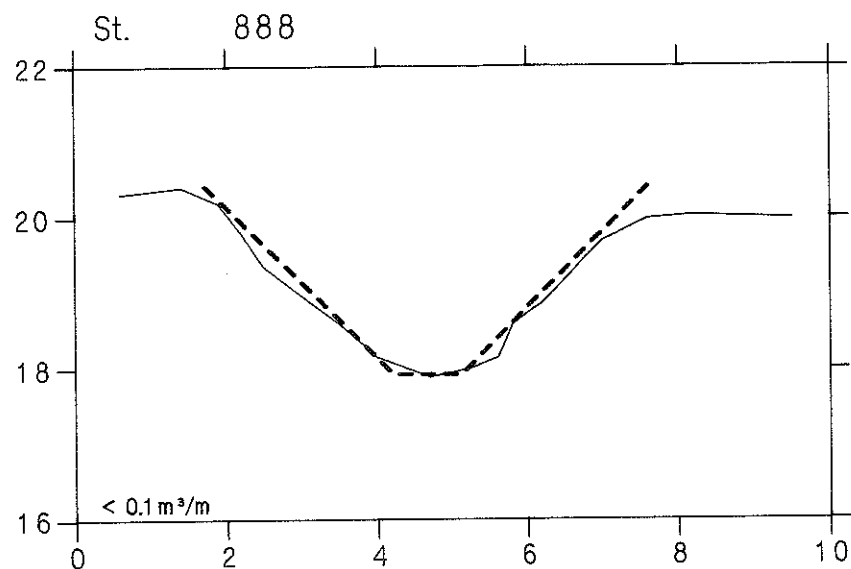
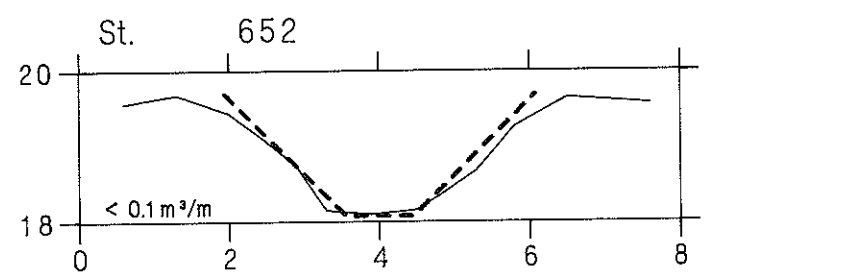

# Marbækrenden



— Opmåling foretaget af DDH/Slagelse 1989

- - - - - Nyt regulativ

lodret akse : kote i m skala 1:100

vandret akse : afstand i m skala 1:100

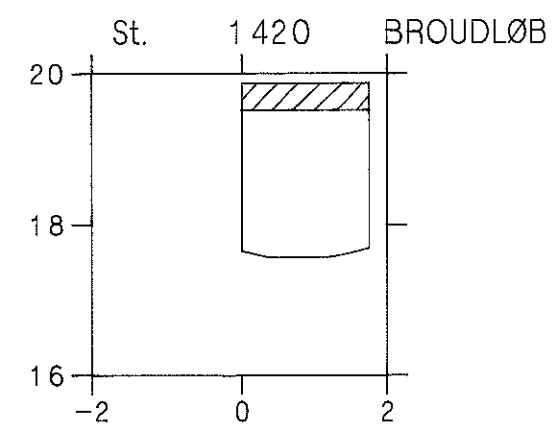
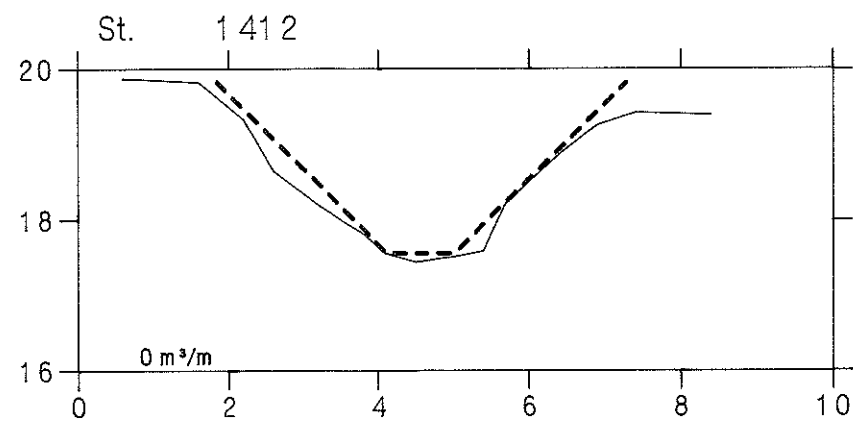
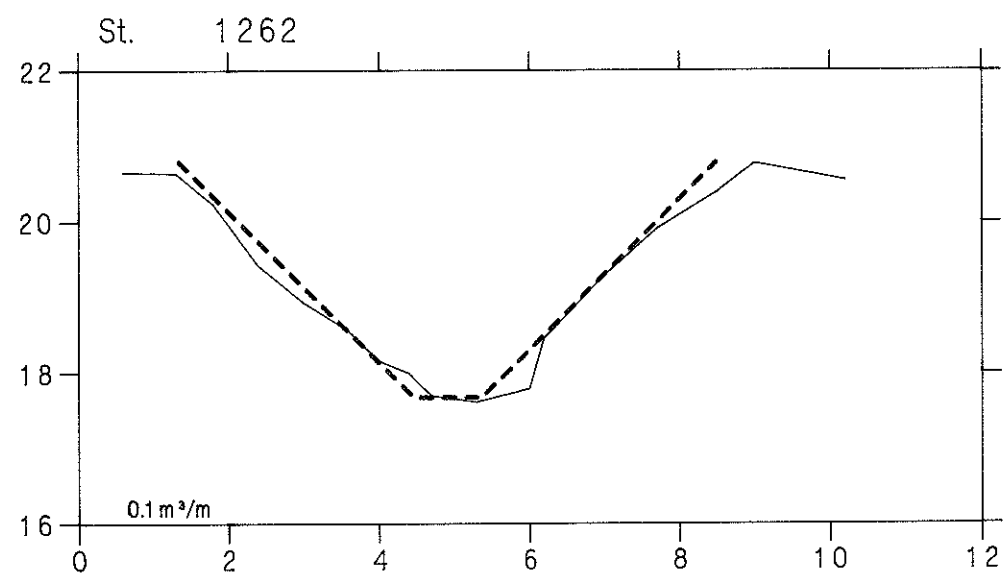
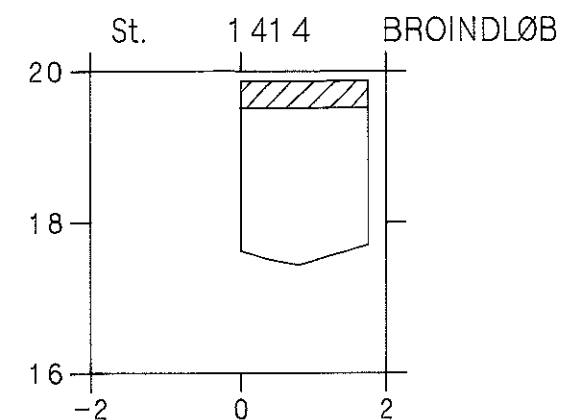
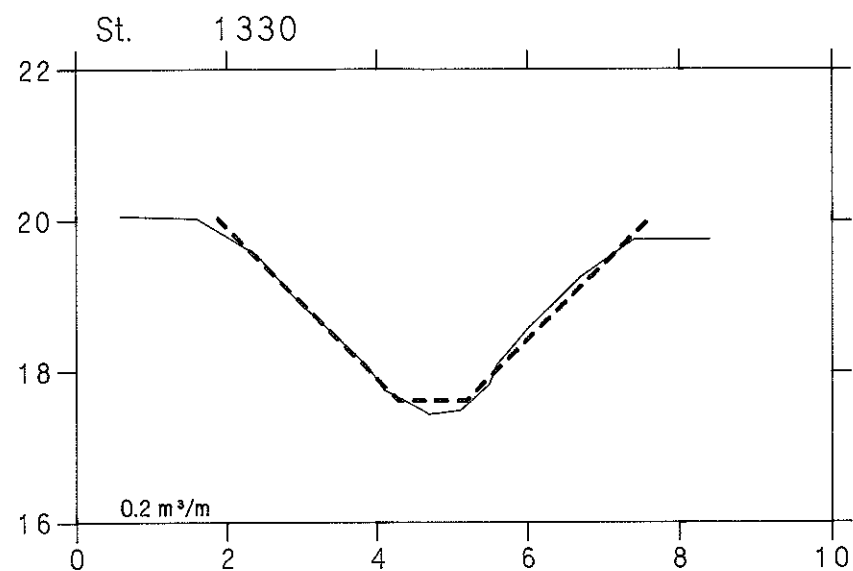
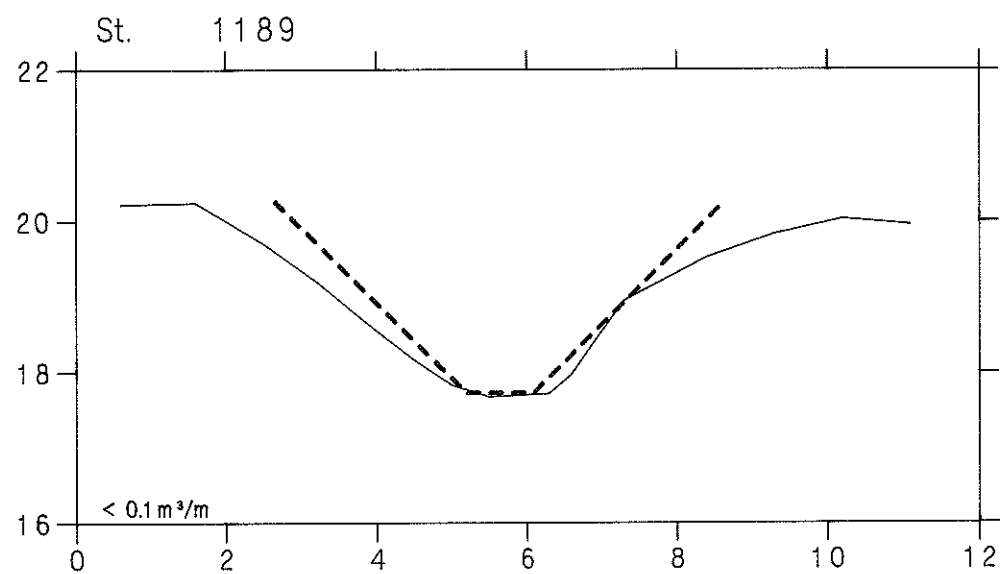

# Marbækrenden

VASP 

— Opmåling foretaget af DDH/Slagelse 1989

- - - - - Nyt regulativ

lodret akse : kote i m skala 1:100

vandret akse : afstand i m skala 1:100

HEDESELSKABET

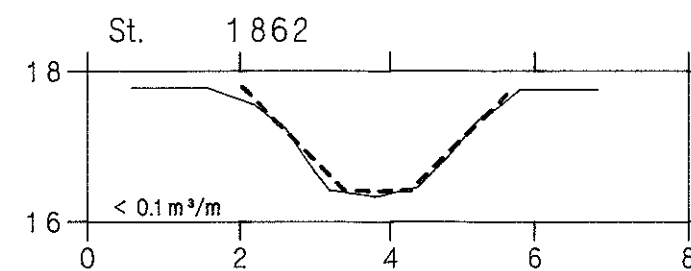
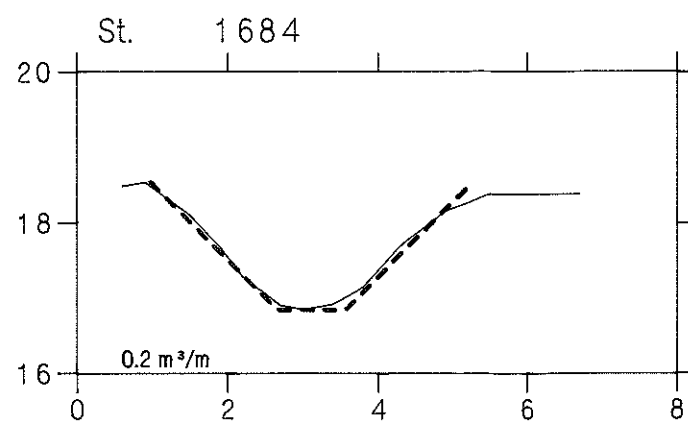
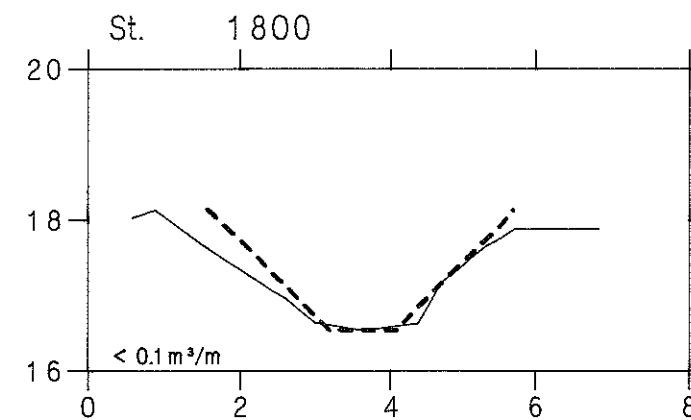
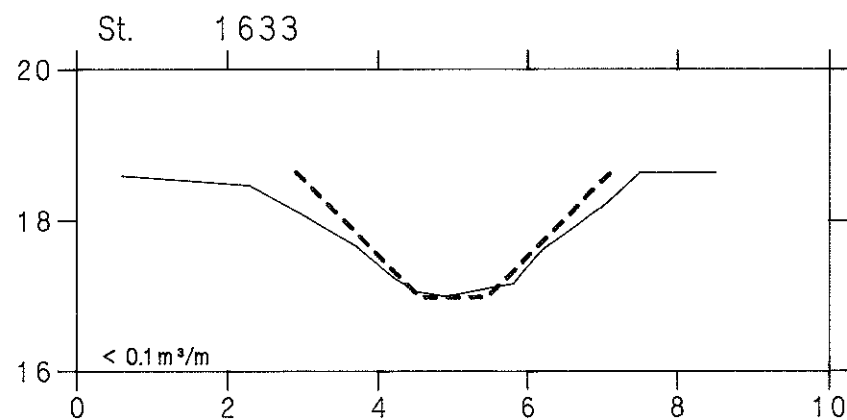
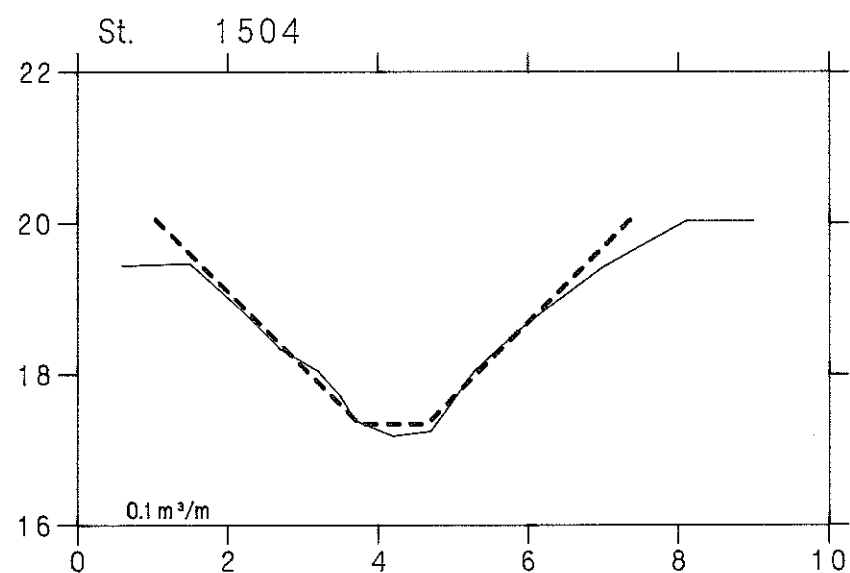
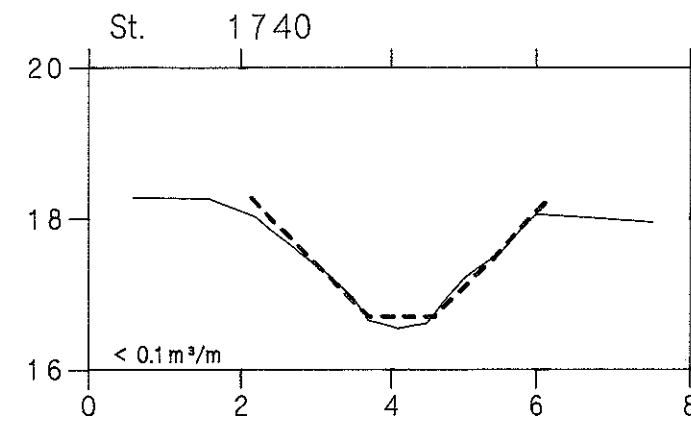
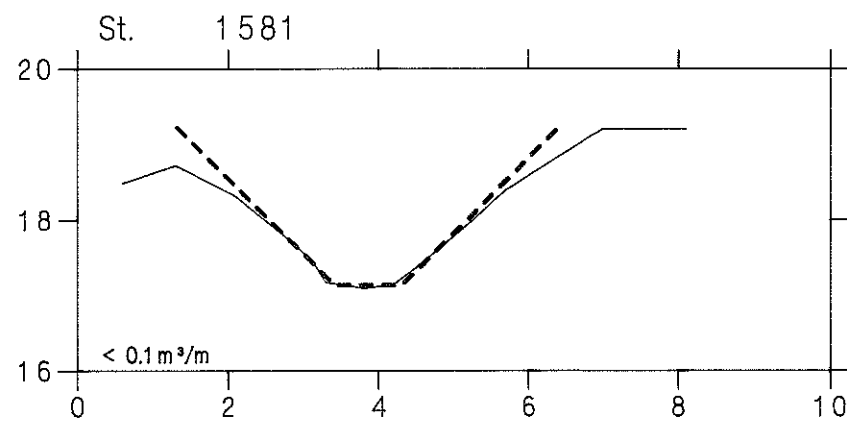
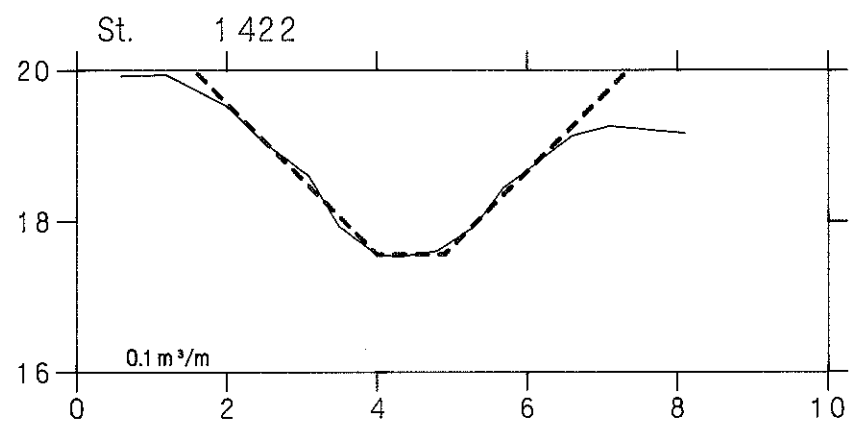

# Marbækrenden



HEDESELSKABET



— Opmåling foretaget af DDH/Slagelse 1989

- - - - - Nyt regulativ

lodret akse : kote i m skala 1:100  
vandret akse : afstand i m skala 1:100

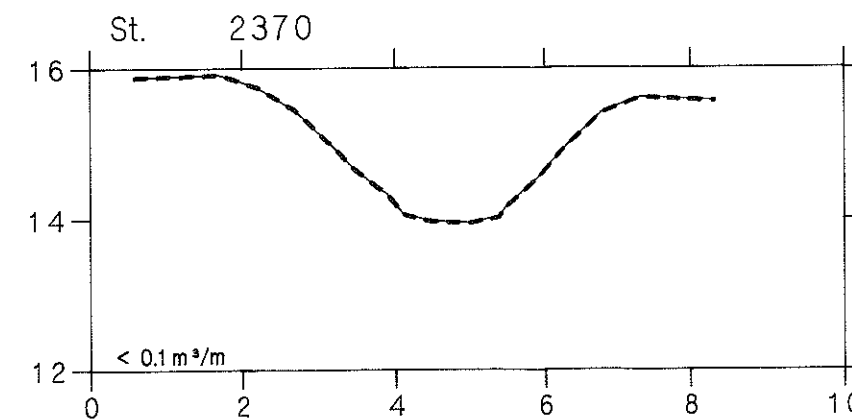
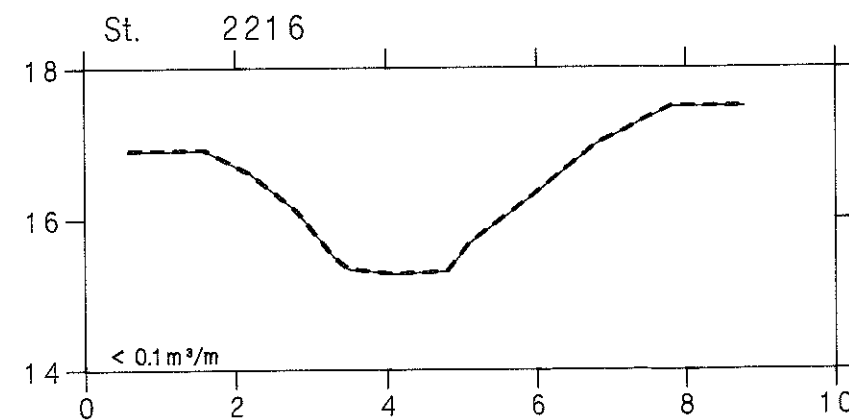
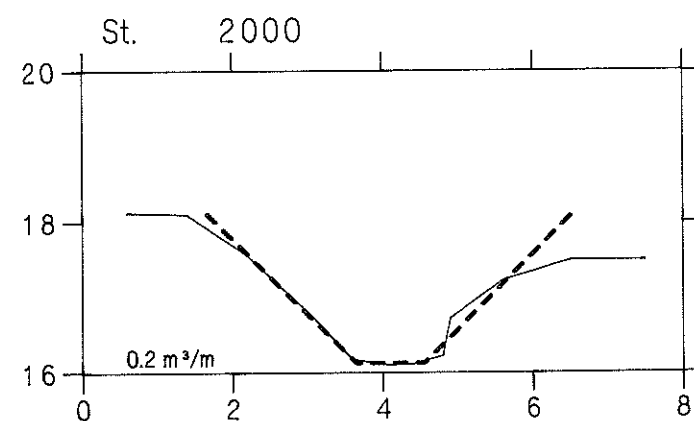
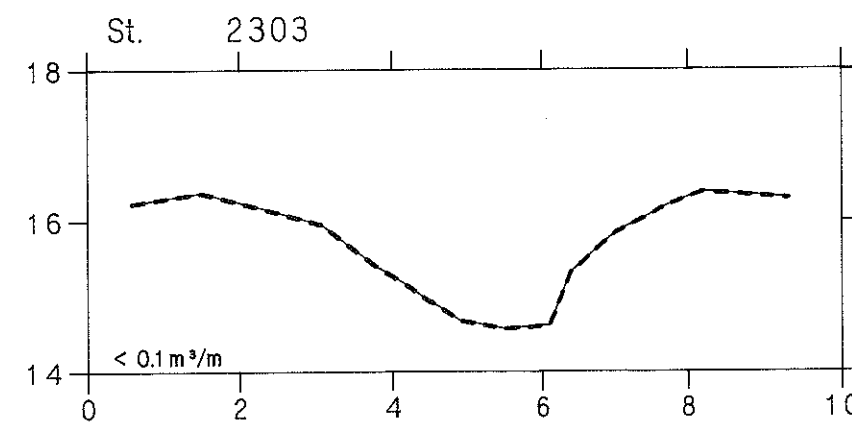
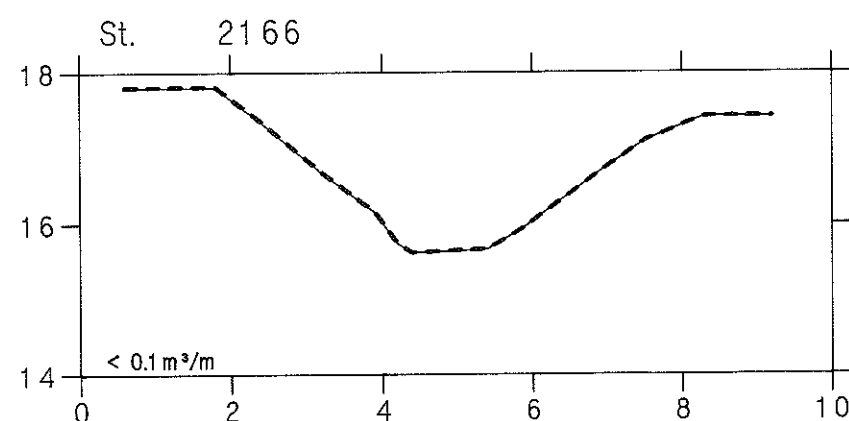
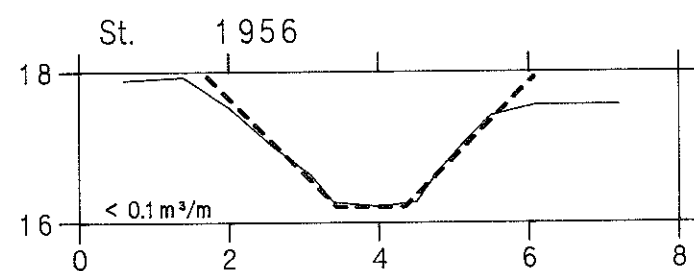
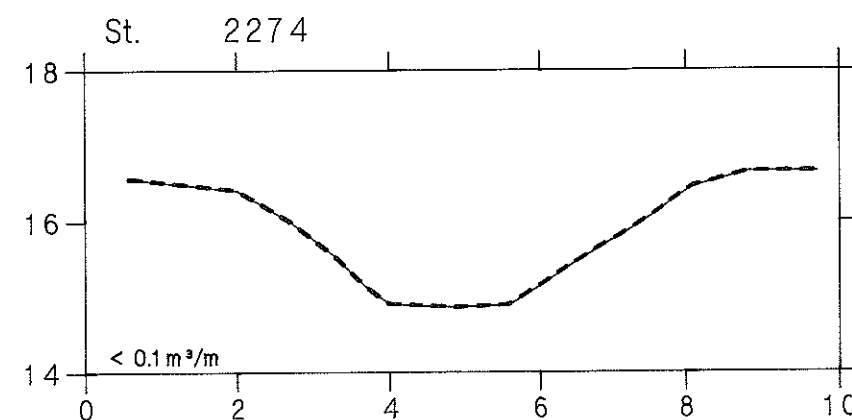
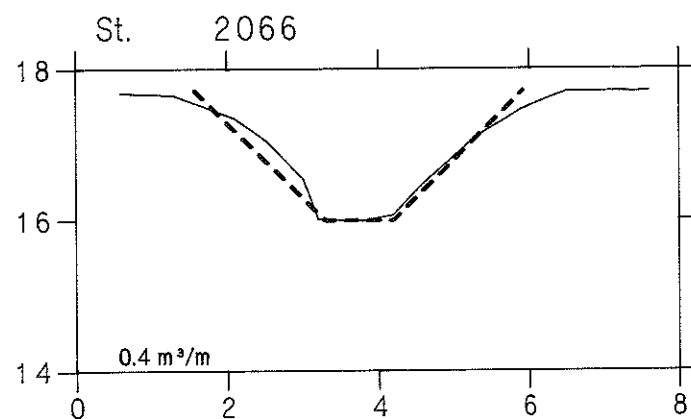
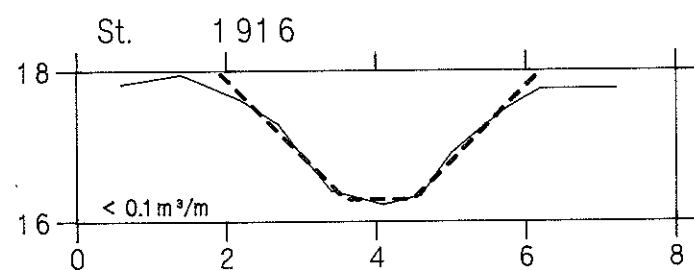

# Marbækrenden

VASP 

HEDESELSKABET 

— Opmåling foretaget af DDH/Slagelse 1989  
- - - - - Nyt regulativ

lodret akse : kote i m skala 1:100  
vandret akse : afstand i m skala 1:100

