

TJÆREBY-BASNÆS RENDEN

VASP 

HEDESELSKABET



— Opmåling af DDH/Roskilde feb. 1995

- - - - - Nyt regulativ

lodret akse : kote i m skala 1:100

vandret akse : afstand i m skala 1:100

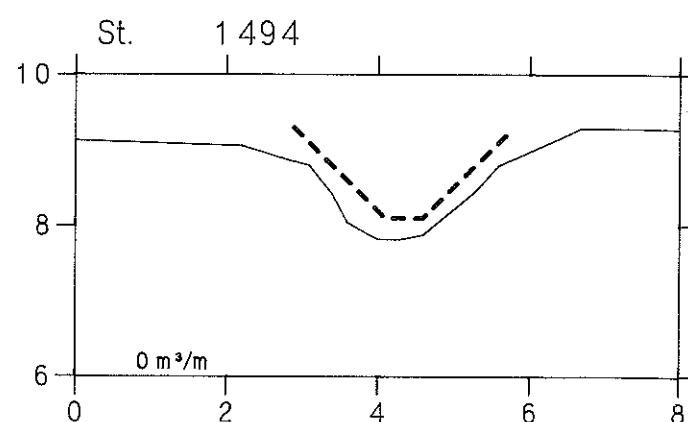
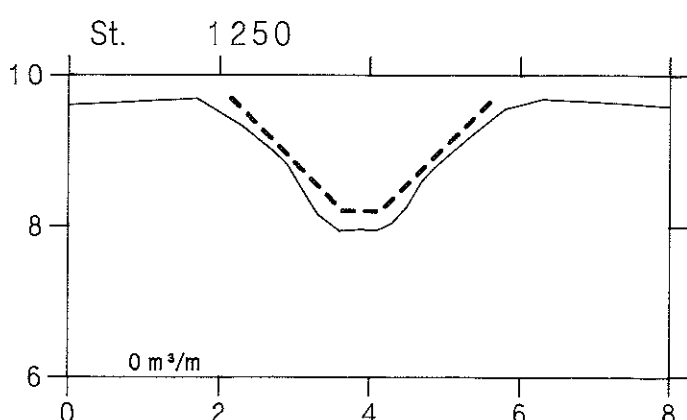
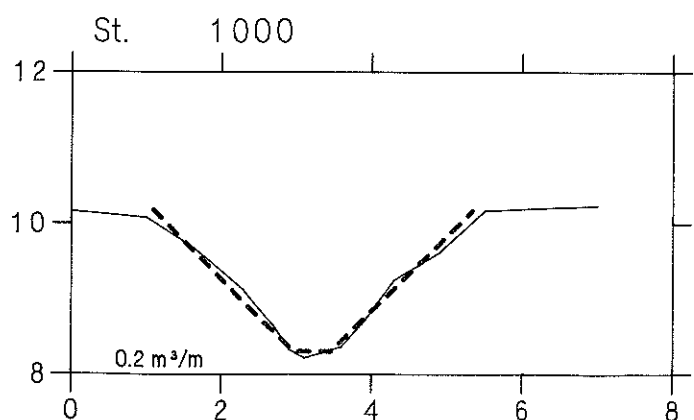
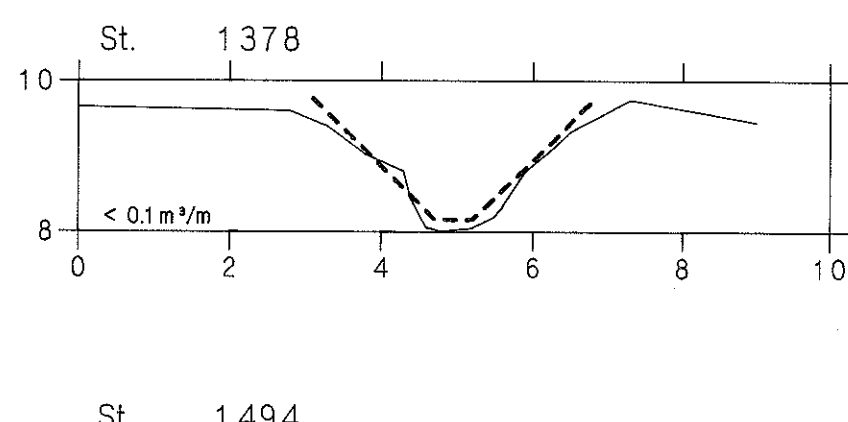
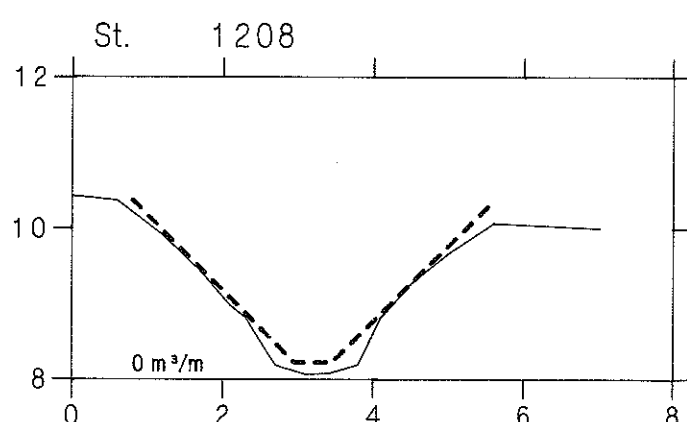
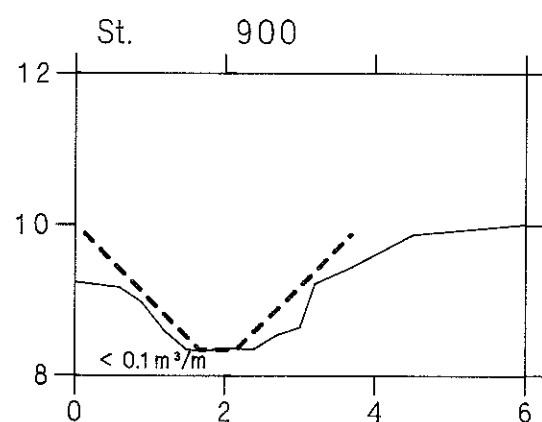
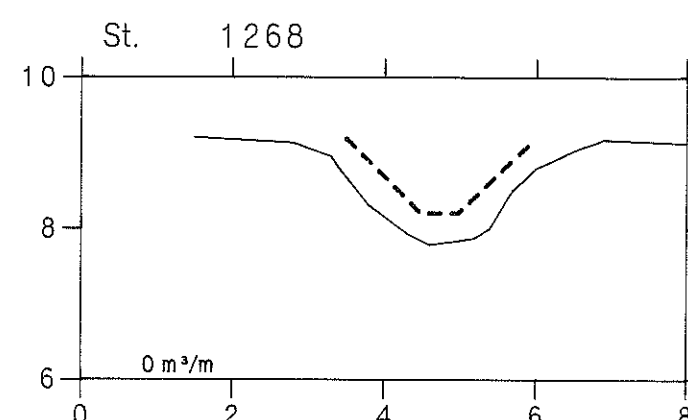
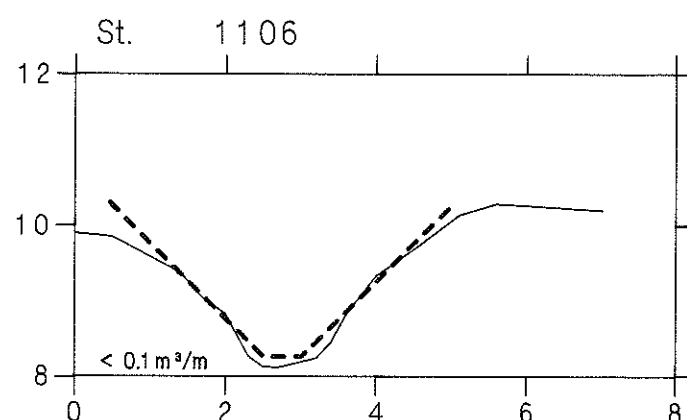
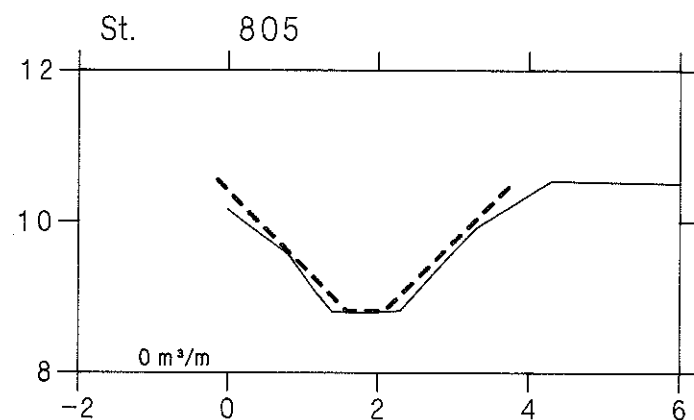

TJÆREBY-BASNÆS RENDEN

VASP 

HEDESELSKABET 

— Opmåling af DDH/Roskilde feb. 1995

- - - - - Nyt regulativ

lodret akse : kote i m skala 1:100

vandret akse : afstand i m skala 1:100

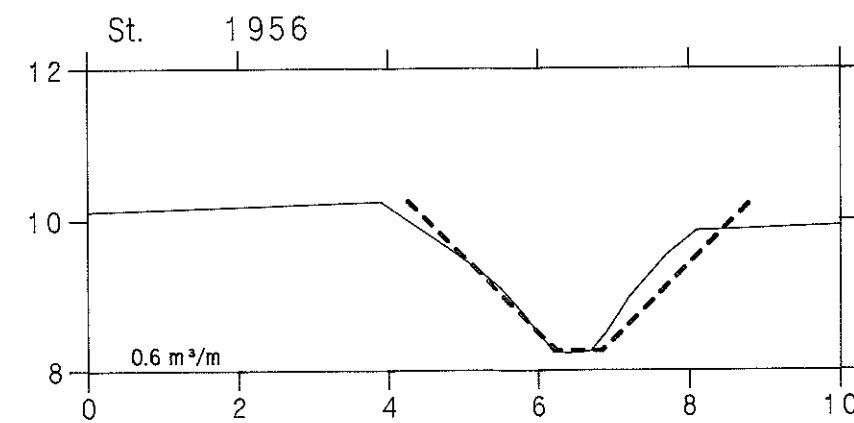
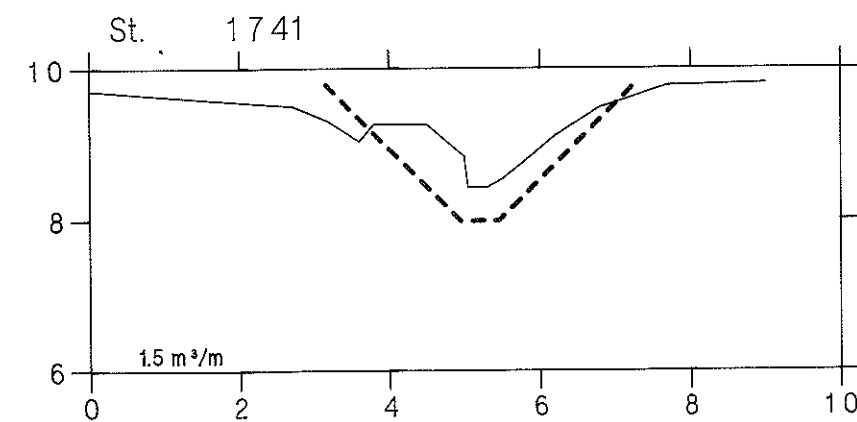
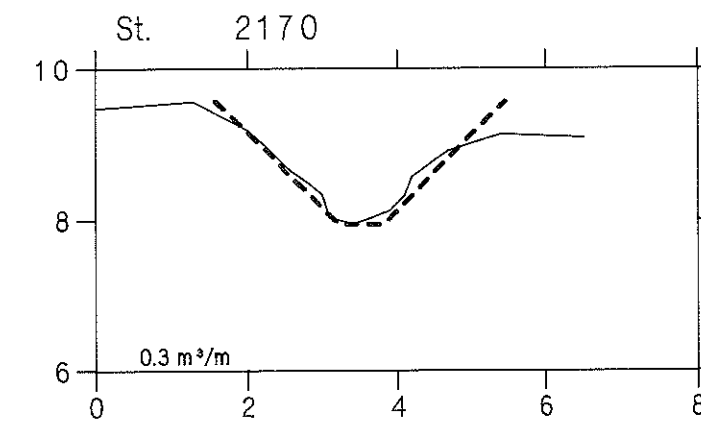
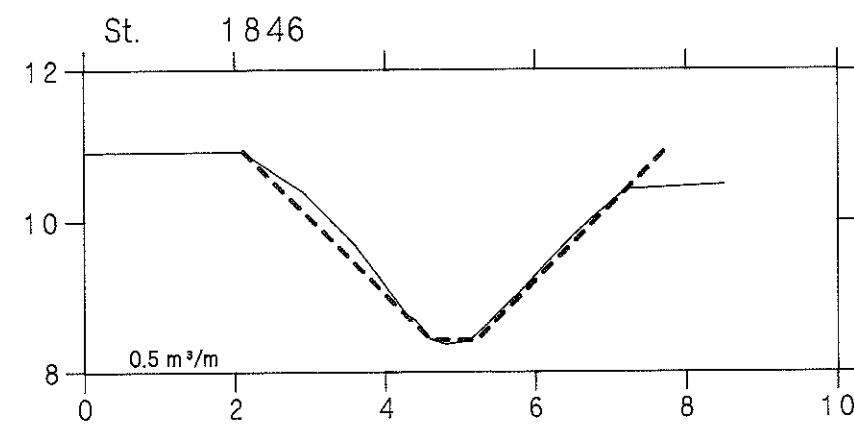
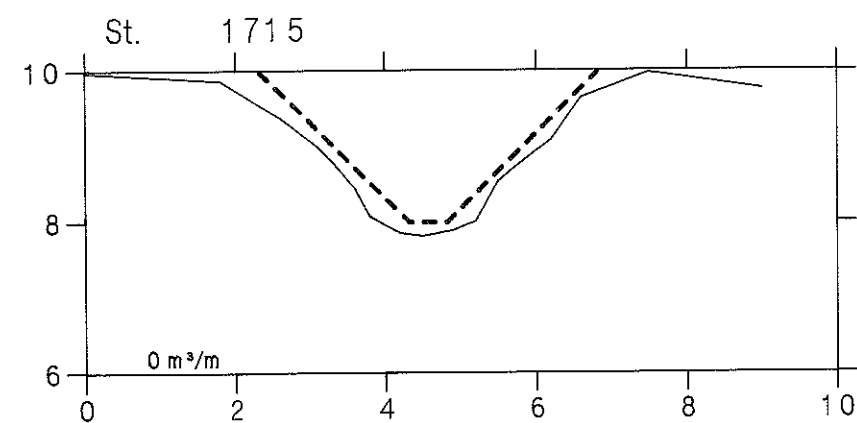
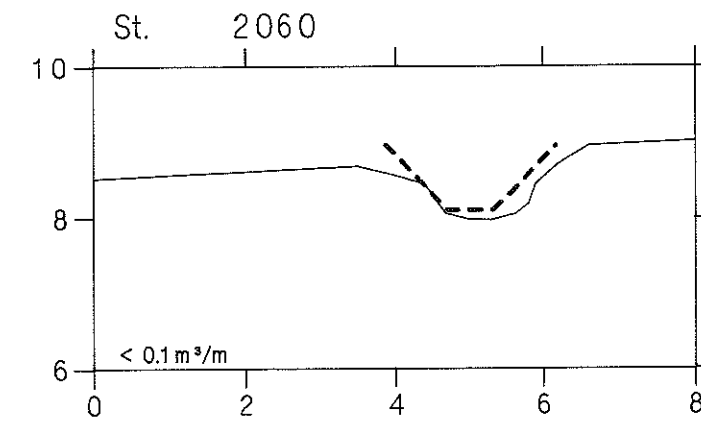
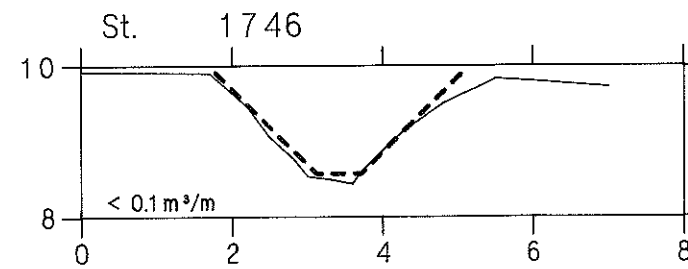
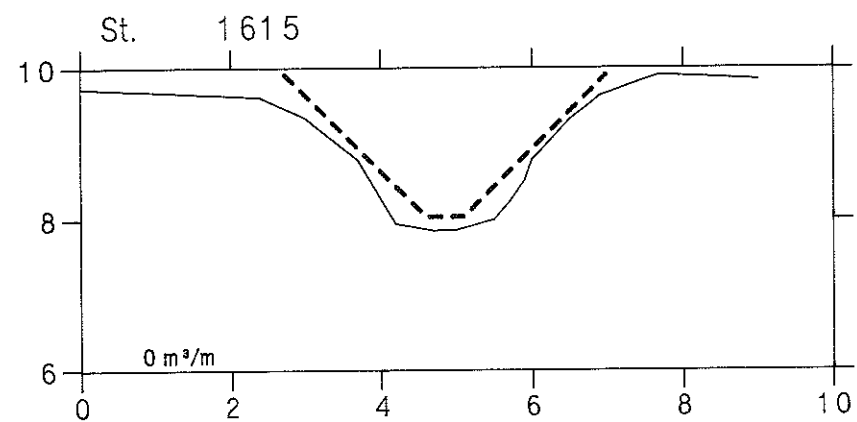

TJÆREBY-BASNÆS RENDEN

VASP 

HEDESELSKABET 

— Opmåling af DDH/Roskilde feb. 1995

- - - - - Nyt regulativ

lodret akse : kote i m skala 1:100

vandret akse : afstand i m skala 1:100

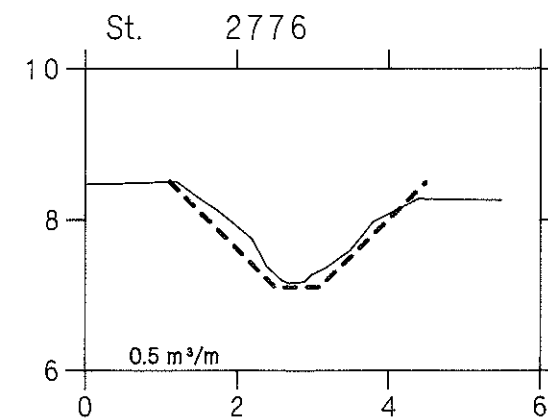
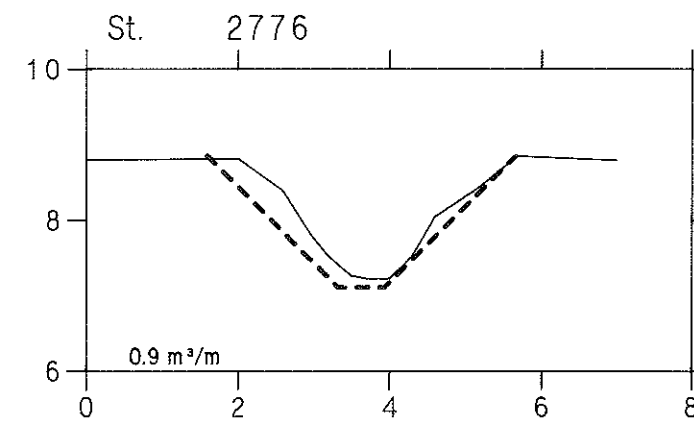
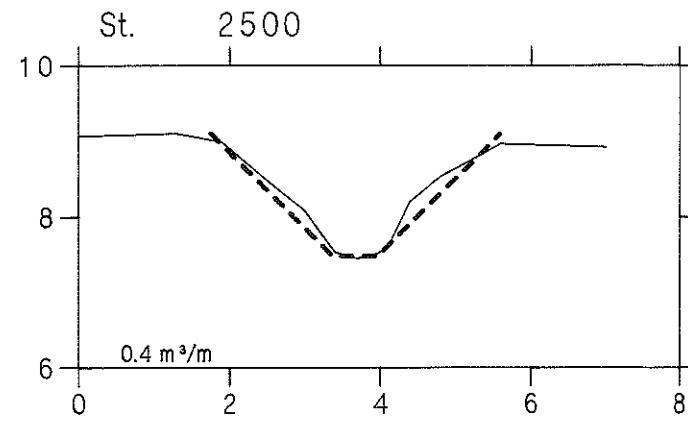
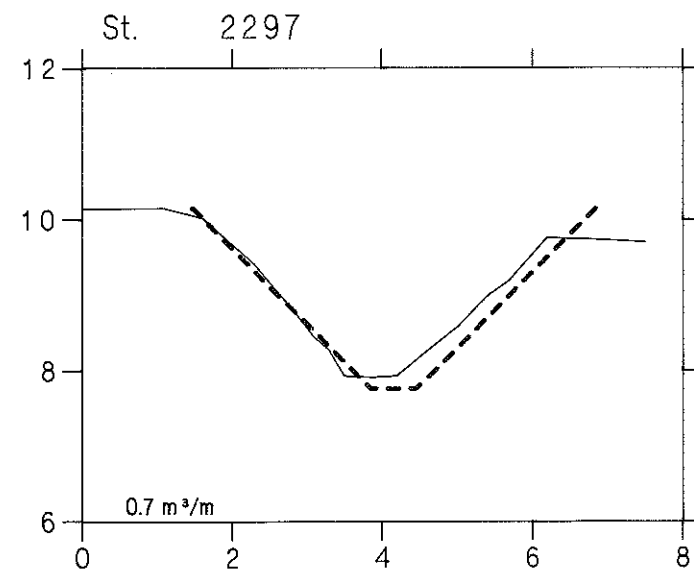
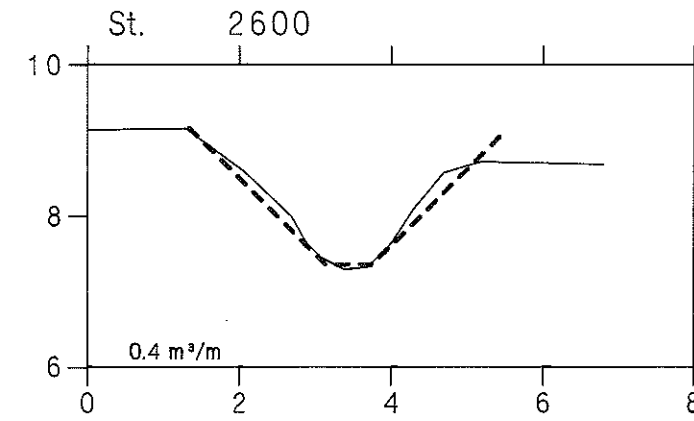
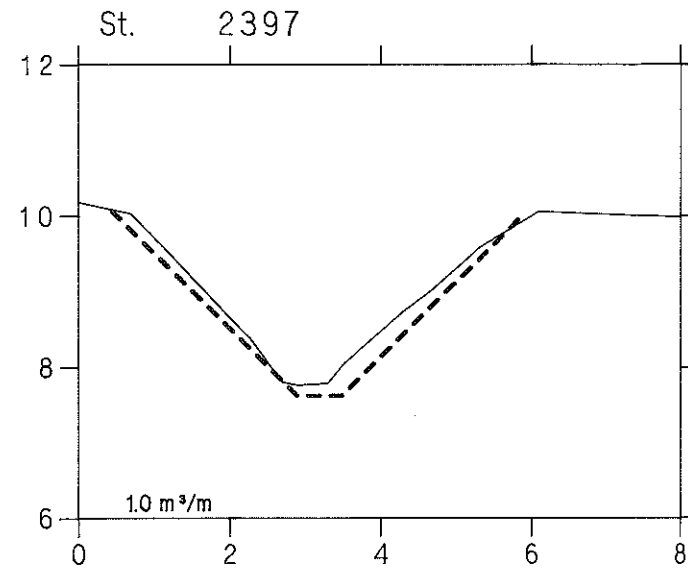
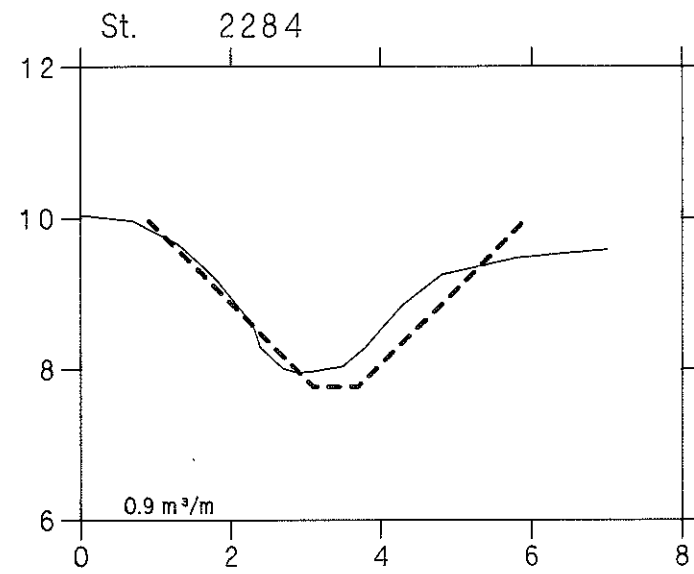

TJÆREBY-BASNÆS RENDEN

VASP 

HEDESELSKABET 

— Opmåling af DDH/Roskilde feb. 1995

- - - - - Nyt regulativ

lodret akse : kote i m skala 1:100

vandret akse : afstand i m skala 1:100

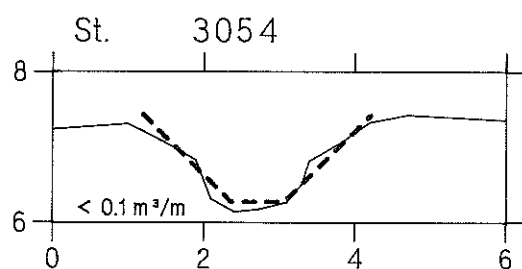
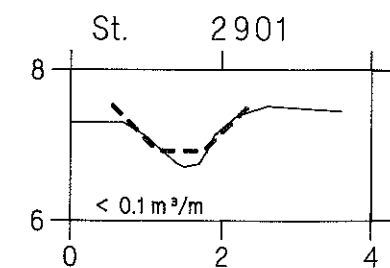
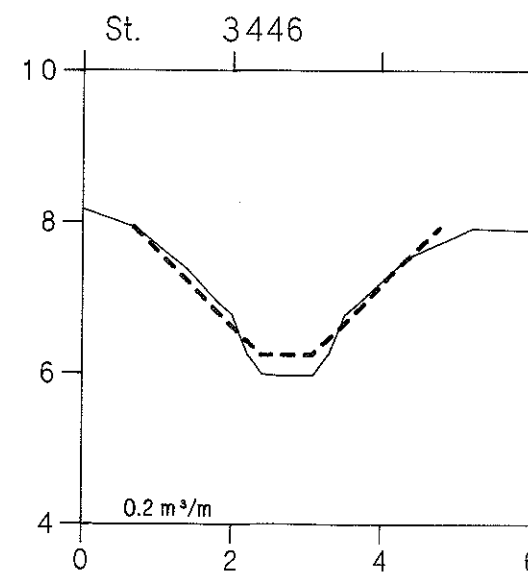
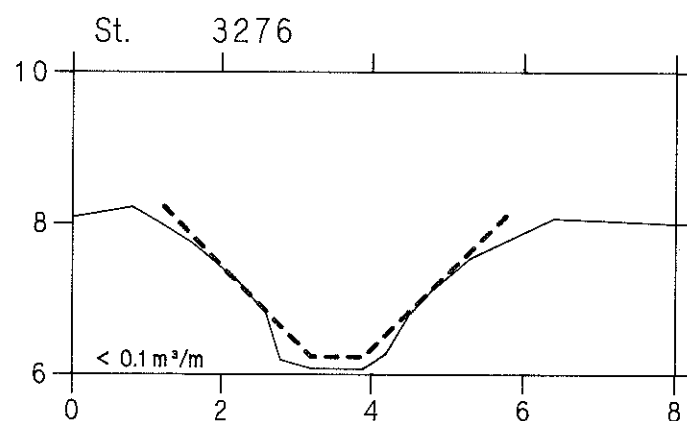
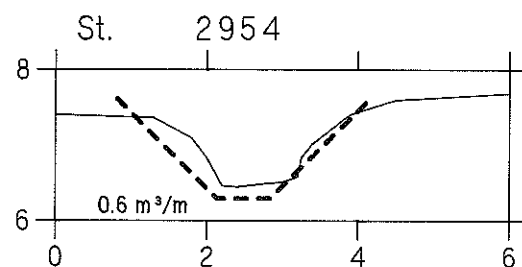
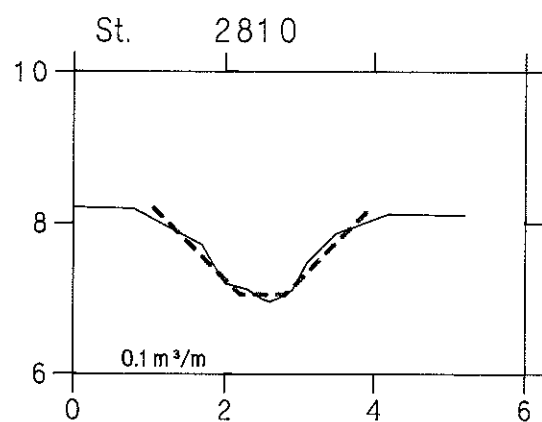
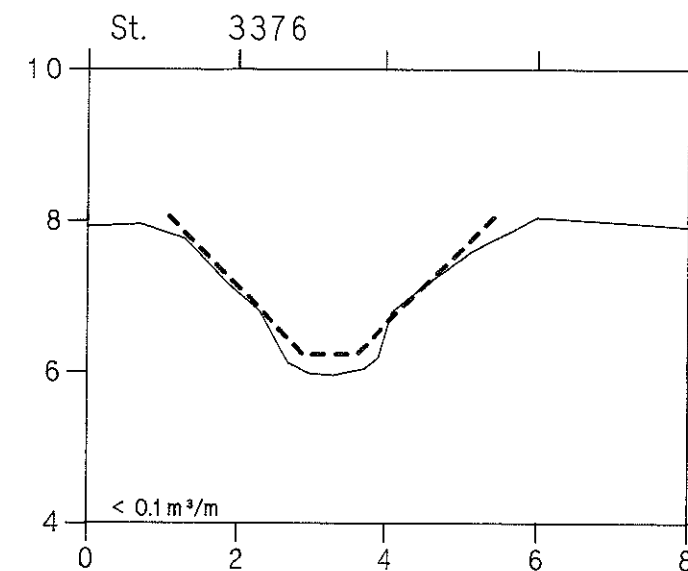
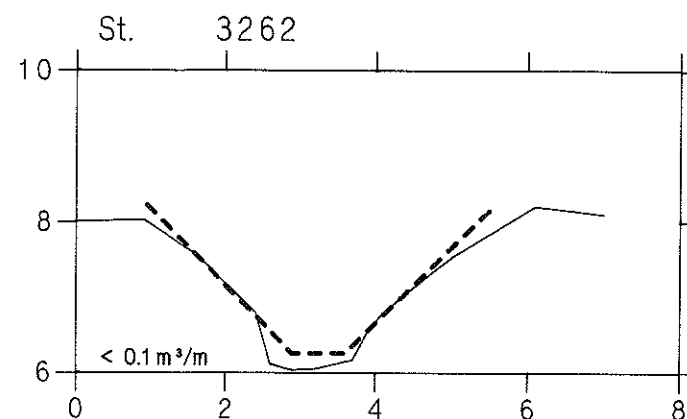
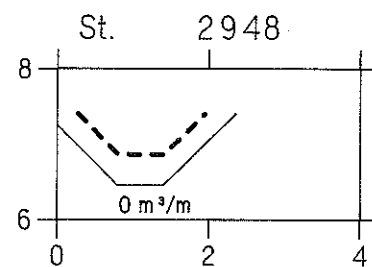
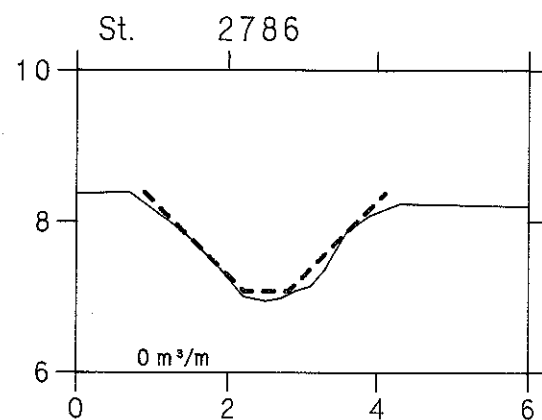

TJÆREBY-BASNÆS RENDEN

VASP 

HEDESELSKABET 

— Opmåling af DDH/Roskilde feb. 1995

- - - - - Nyt regulativ

lodret akse : kote i m skala 1:100
vandret akse : afstand i m skala 1:100

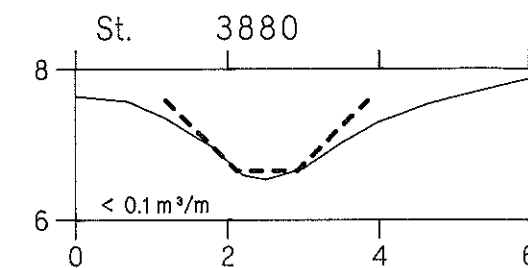
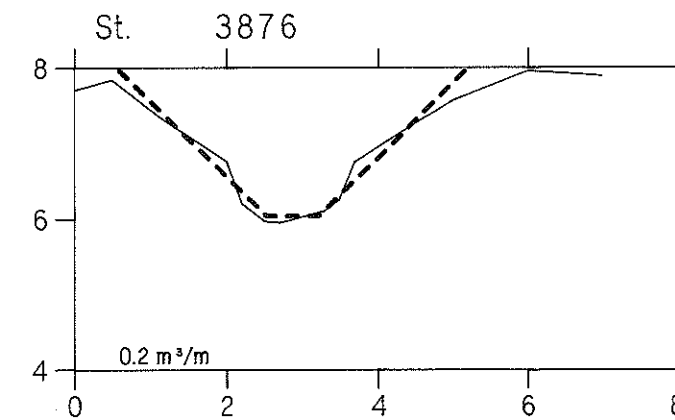
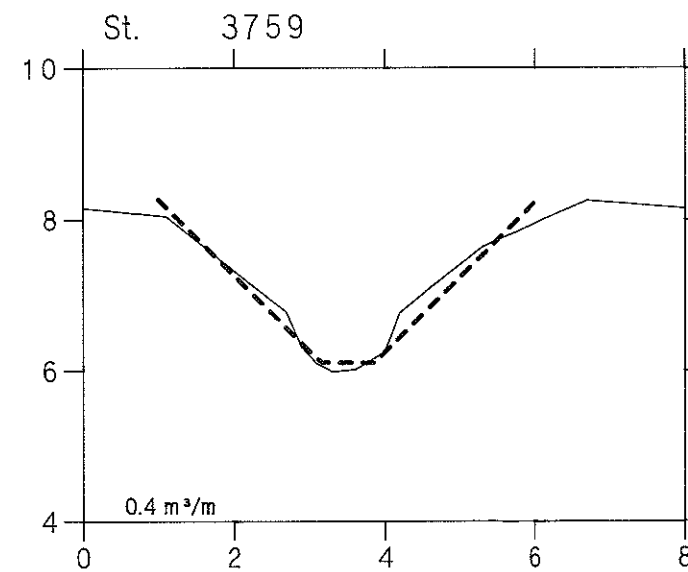
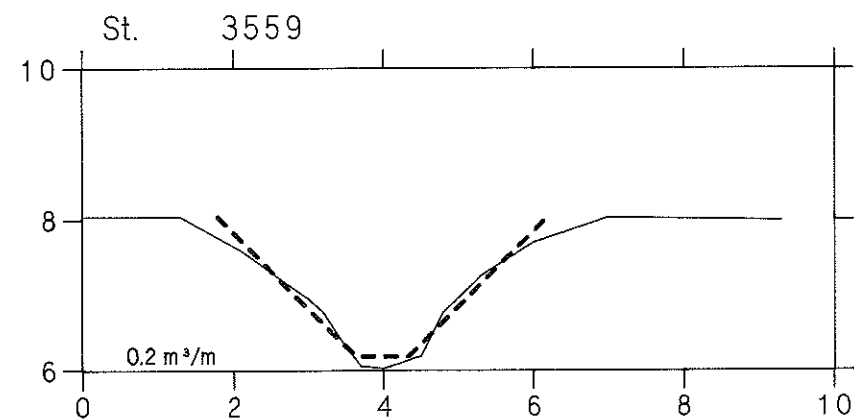
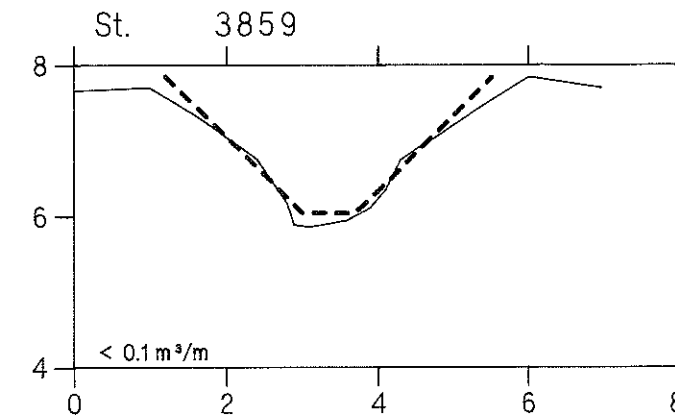
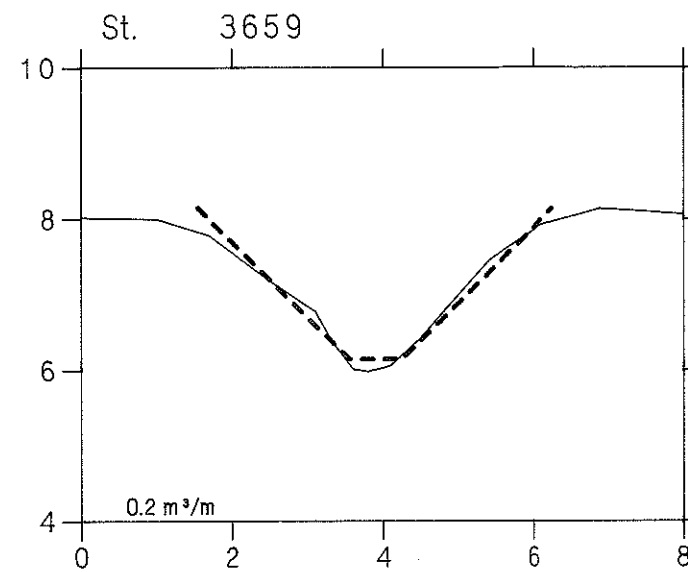
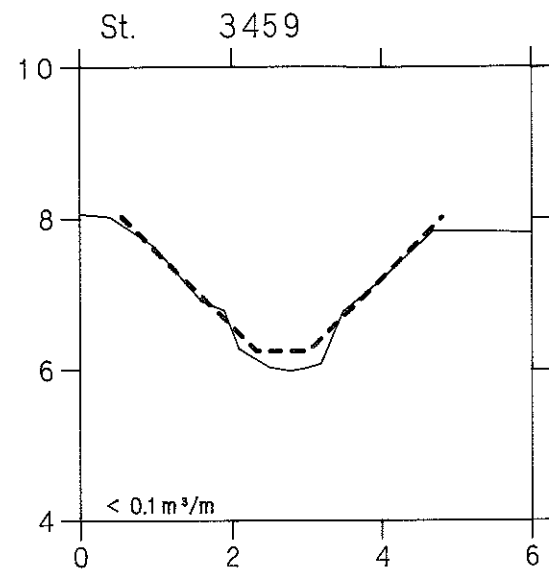

TJÆREBY-BASNÆS RENDEN

VASP 

HEDESELSKABET 

— Opmåling af DDH/Roskilde feb. 1995

- - - - - Nyt regulativ

Iodret akse : kote i m skala 1:100

vandret akse : afstand i m skala 1:100

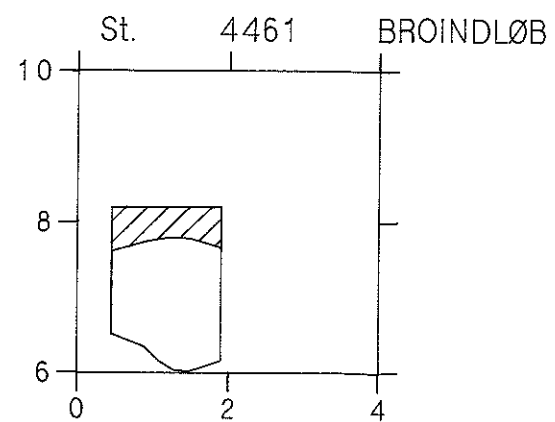
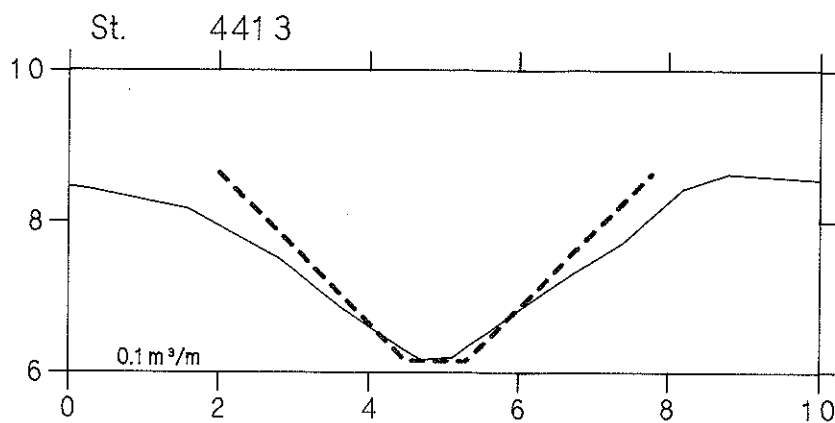
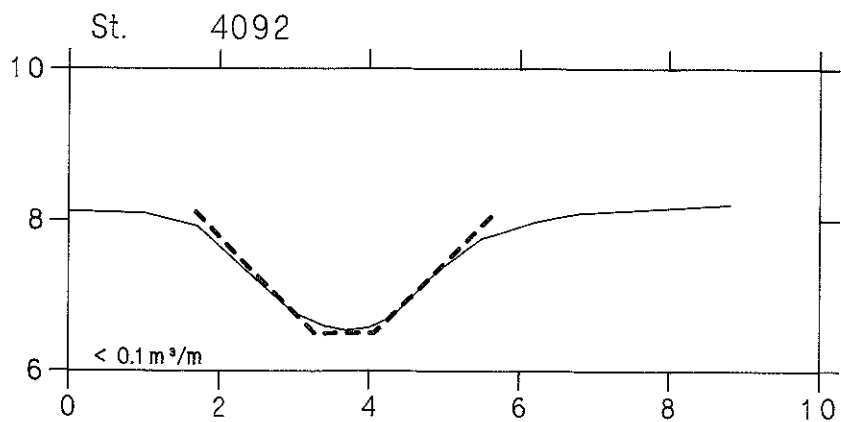
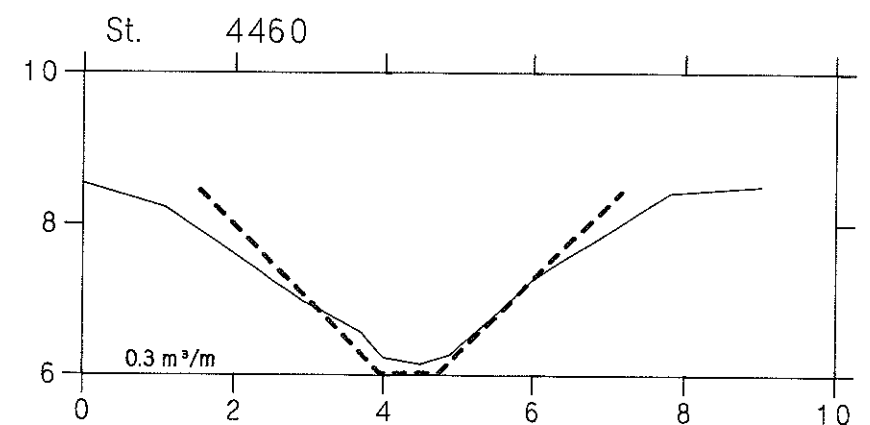
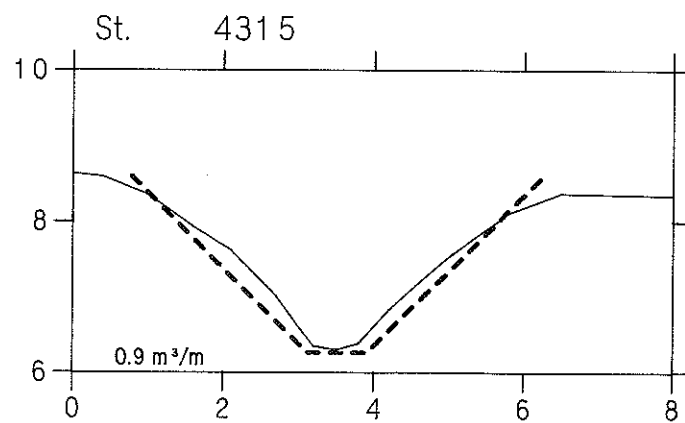
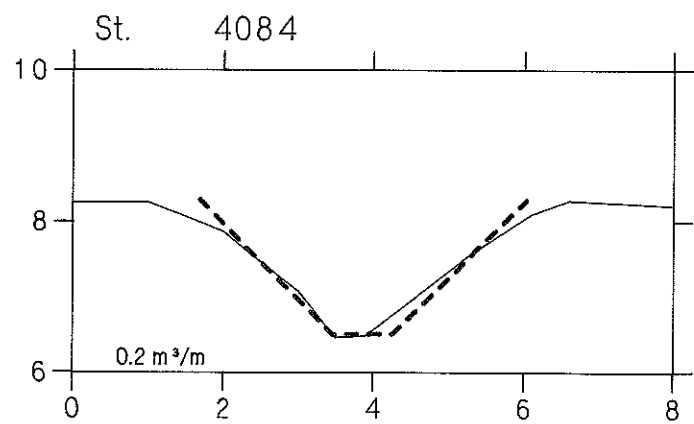
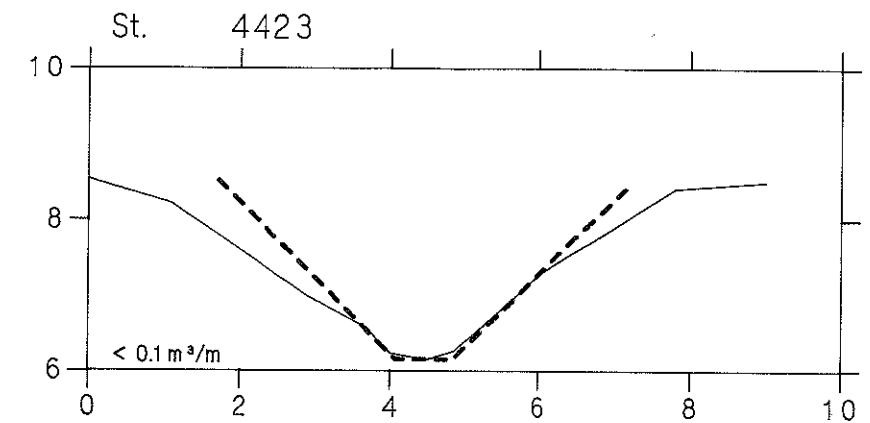
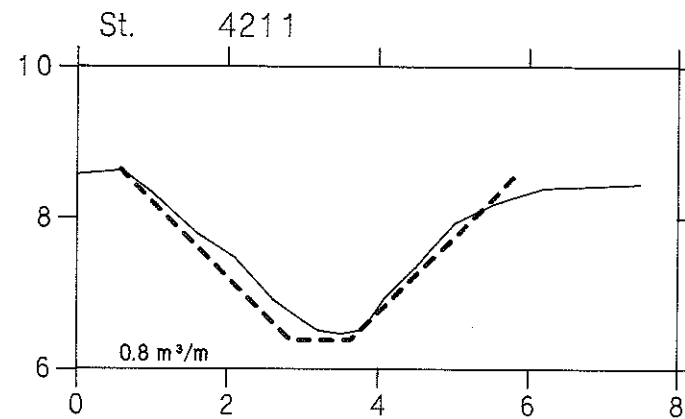
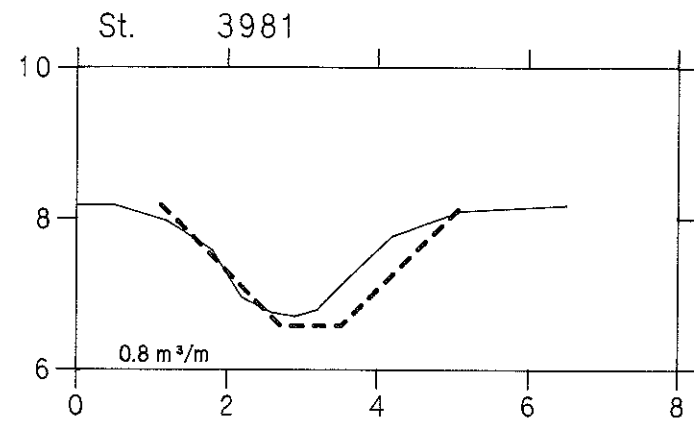

TJÆREBY-BASNÆS RENDEN

VASP 

HEDESELSKABET 

— Opmåling af DDH/Roskilde feb. 1995

- - - - - Nyt regulativ

lodret akse : kote i m skala 1:1 00

vandret akse : afstand i m skala 1:1 00

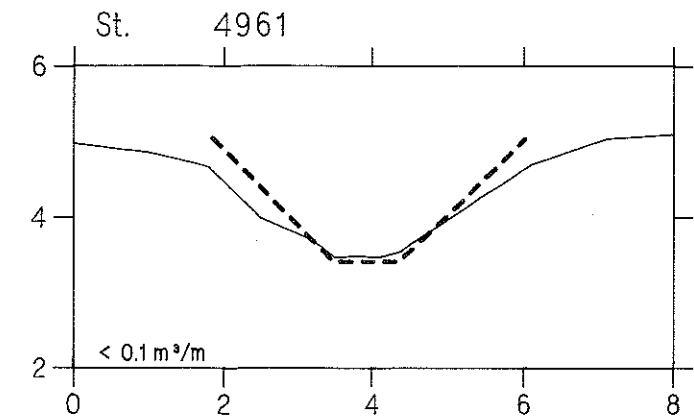
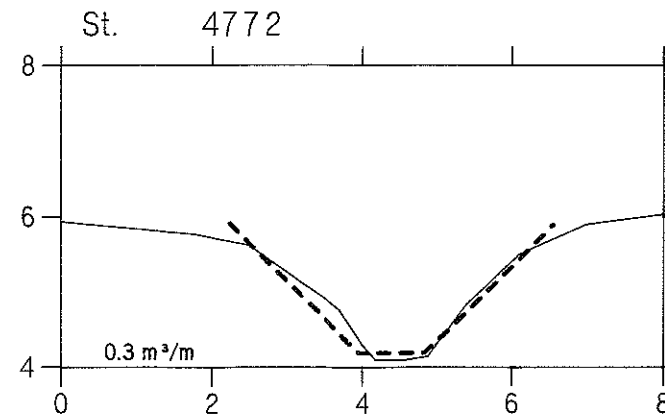
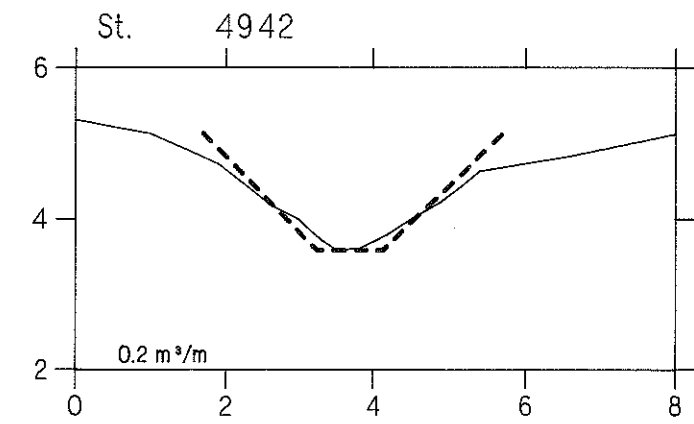
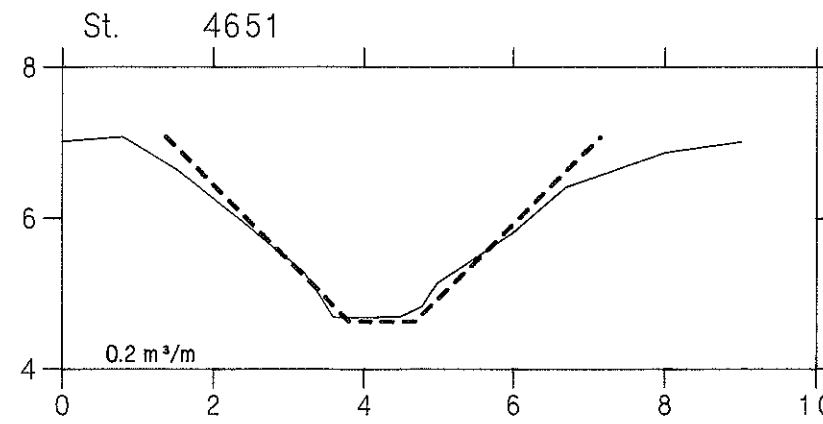
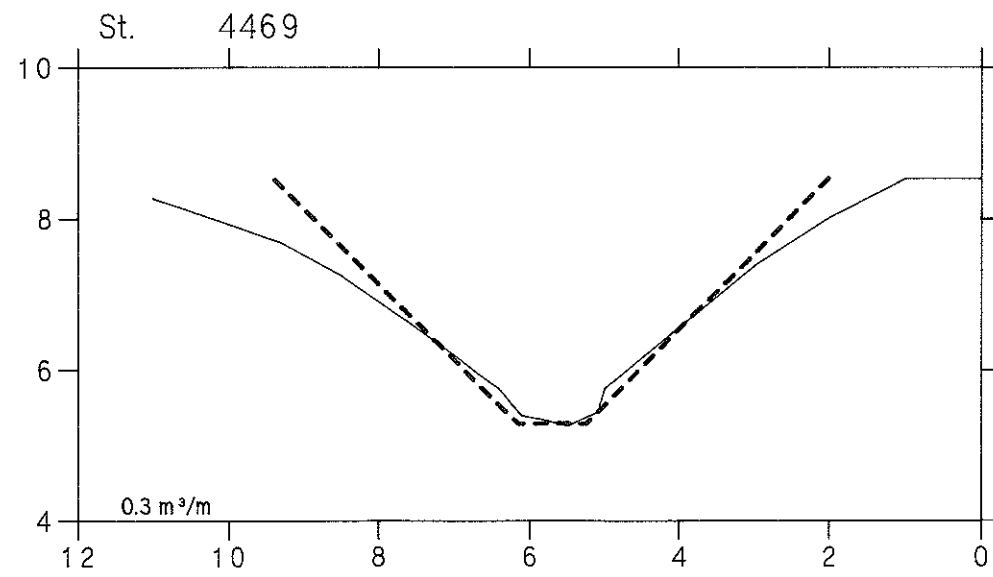
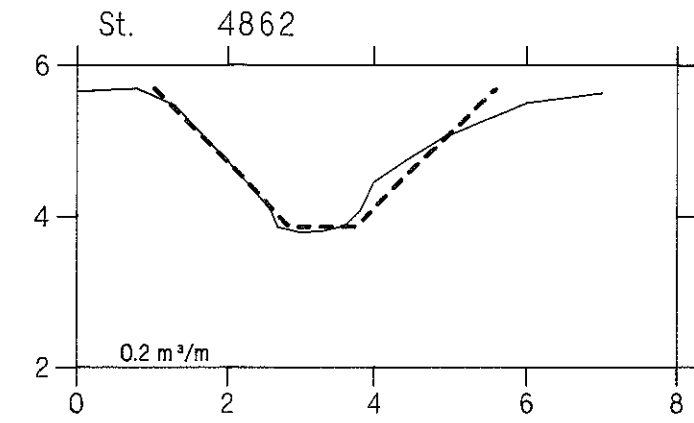
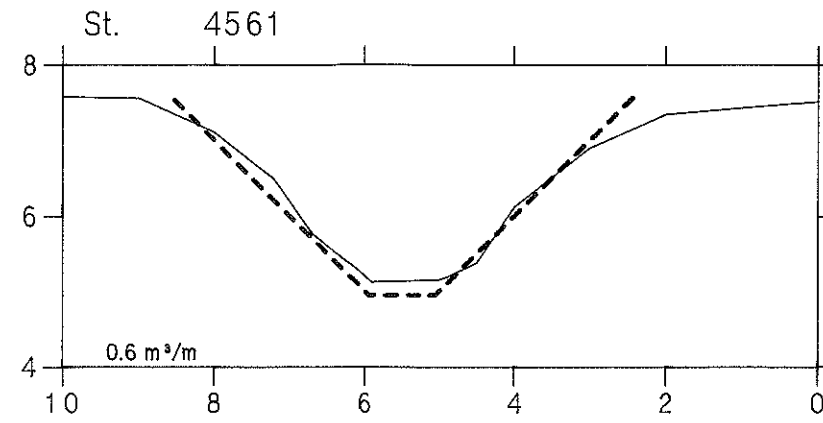
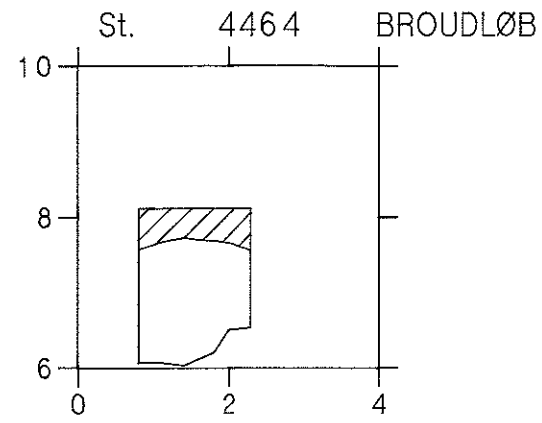

TJÆREBY-BASNÆS RENDEN

VASP 

HEDESELSKABET 

— Opmåling af DDH/Roskilde feb. 1995

- - - - - Nyt regulativ

lodret akse : kote i m skala 1:100

vandret akse : afstand i m skala 1:100

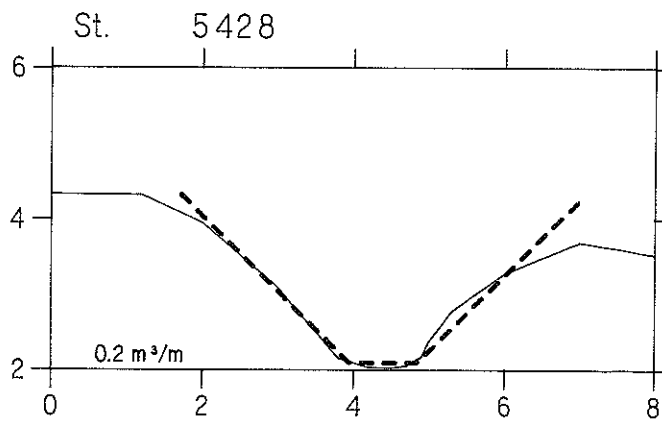
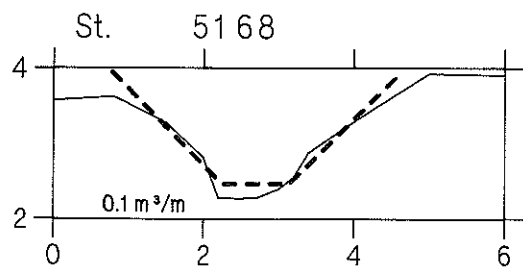
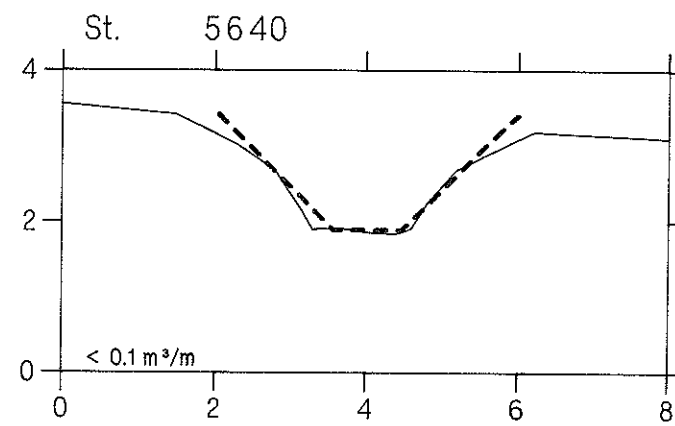
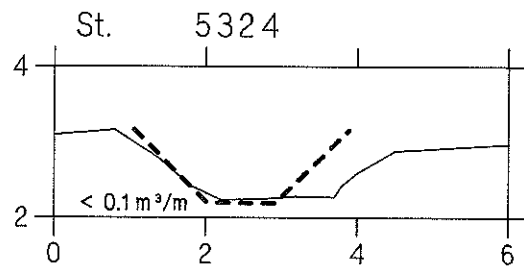
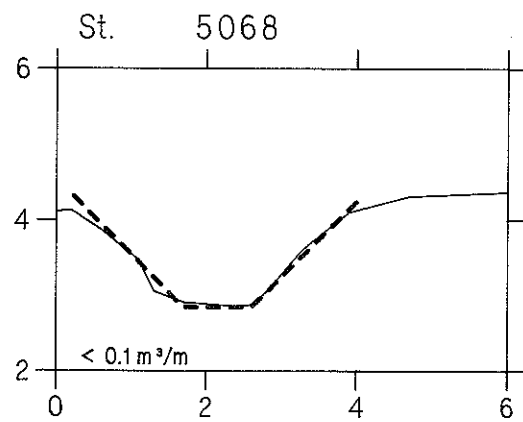
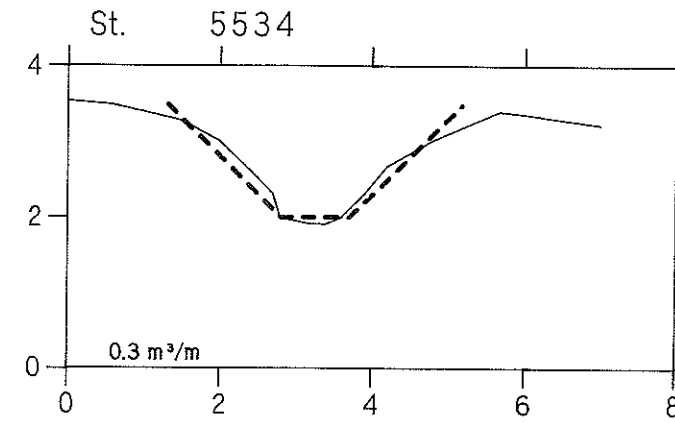
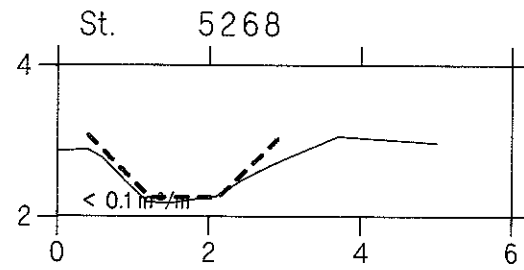
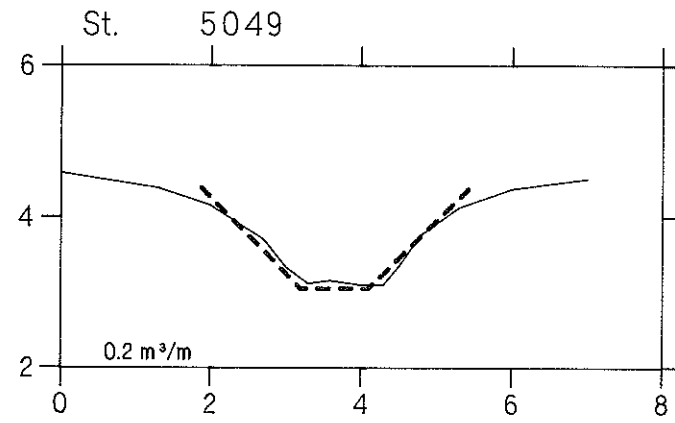

TJÆREBY-BASNÆS RENDEN

VASP 

HEDESELSKABET 

— Opmåling af DDH/Roskilde feb. 1995

- - - - - Nyt regulativ

lodret akse : kote i m skala 1:100

vandret akse : afstand i m skala 1:100

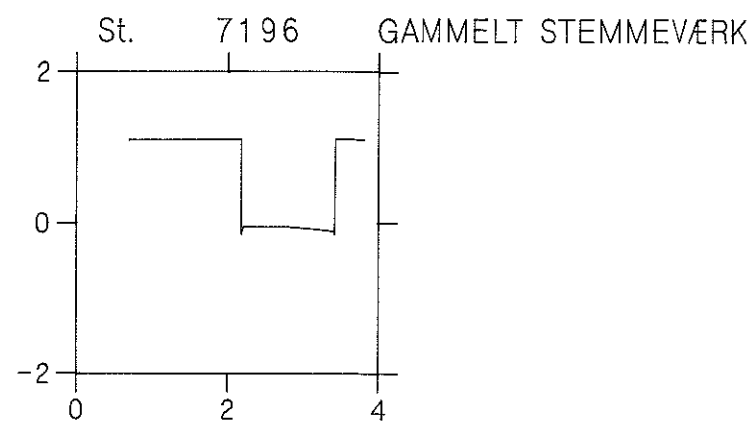
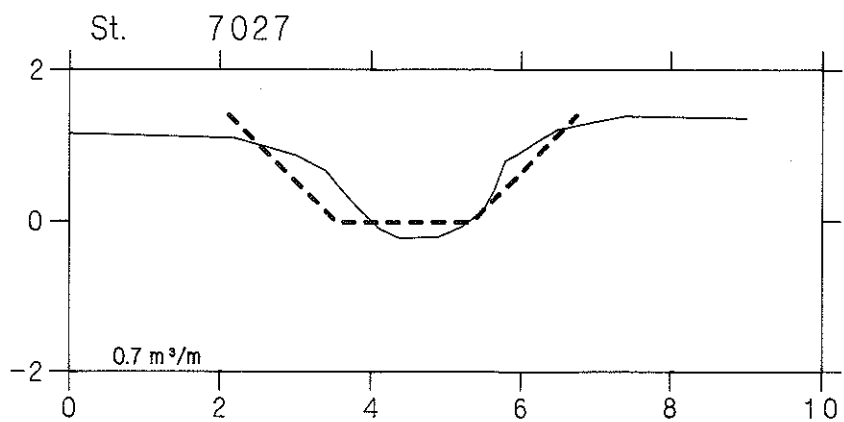
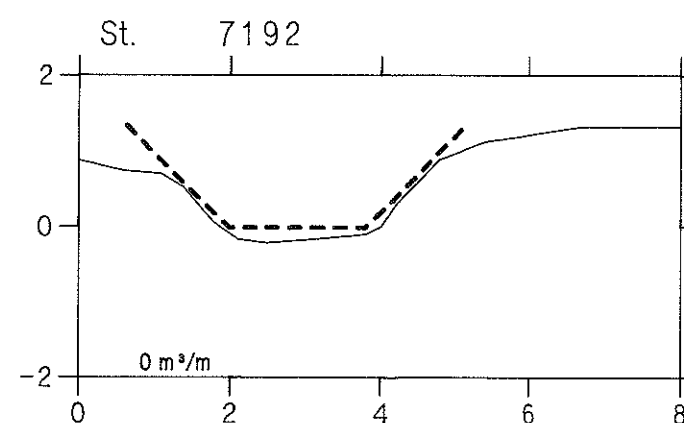
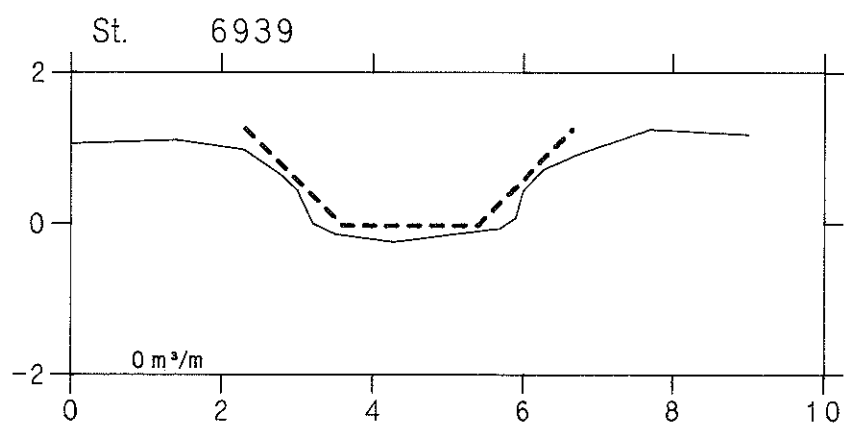
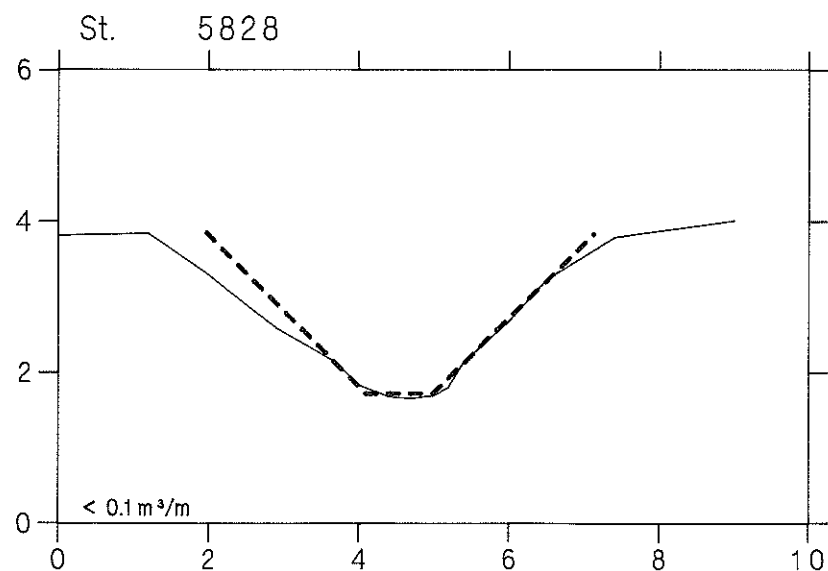
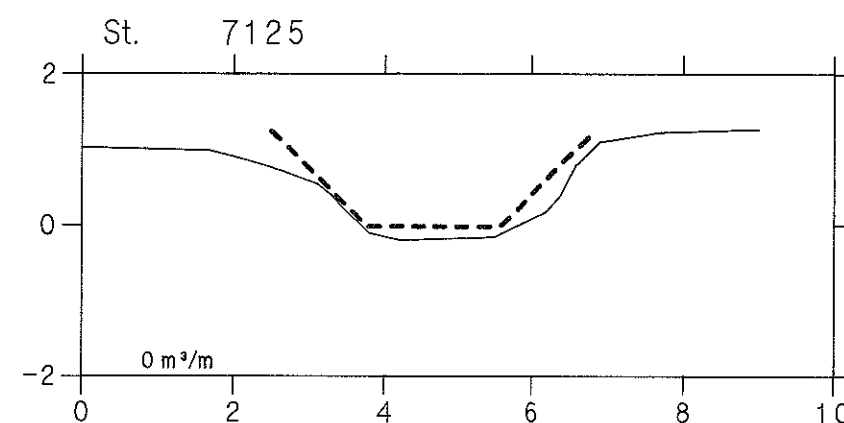
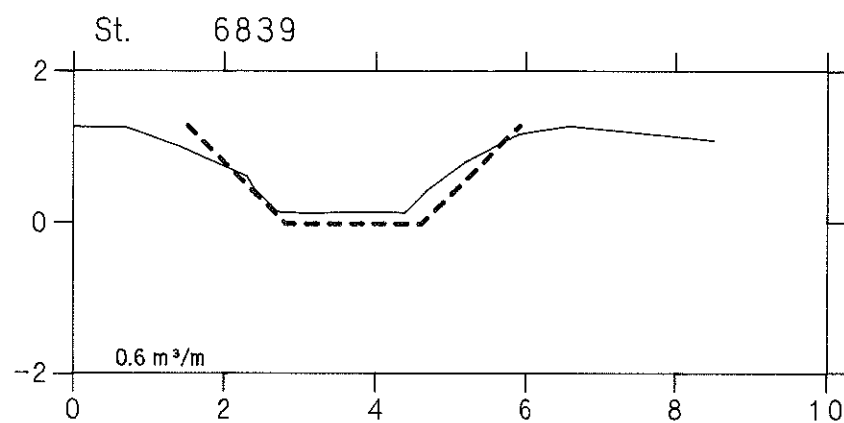
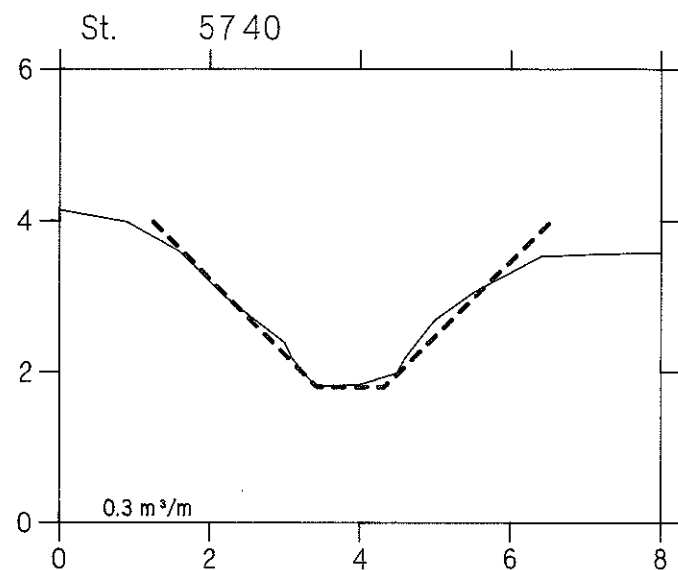

TJÆREBY-BASNÆS RENDEN

VASP 

HEDESELSKABET 

— Opmåling af DDH/Roskilde feb. 1995

- - - - - Nyt regulativ

lodret akse : kote i m skala 1:100

vandret akse : afstand i m skala 1:100

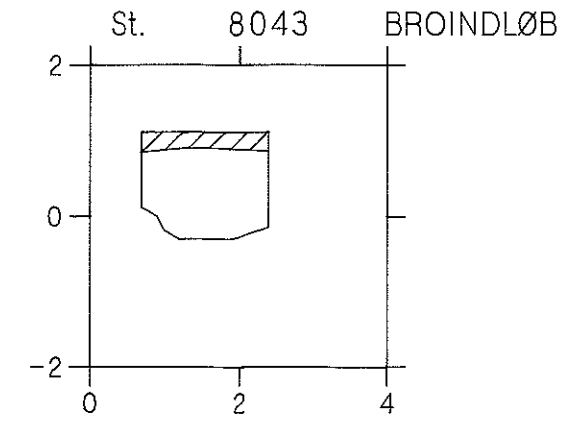
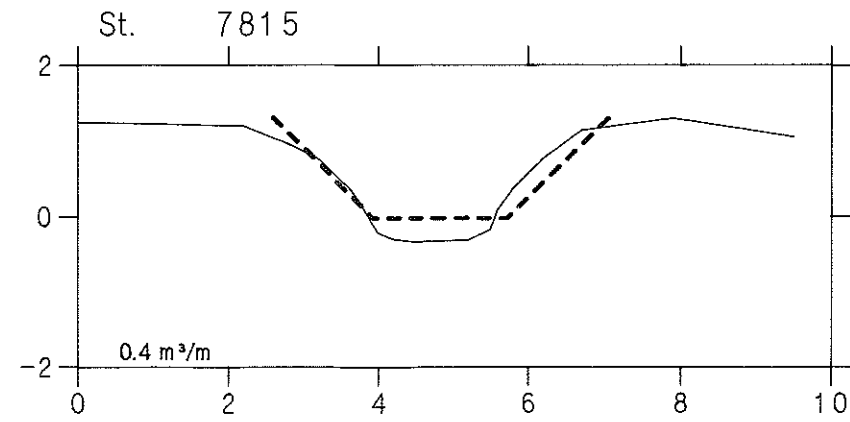
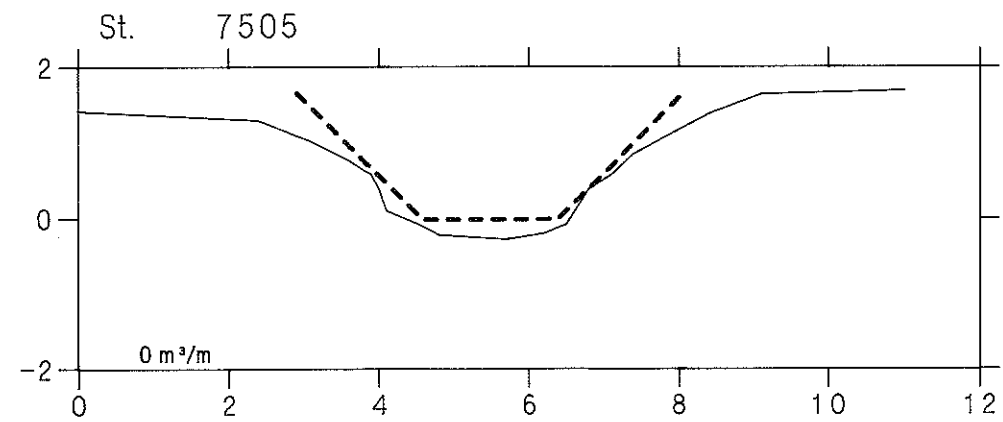
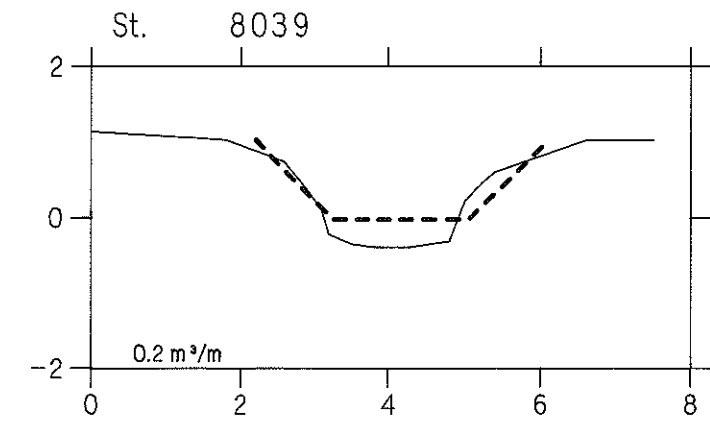
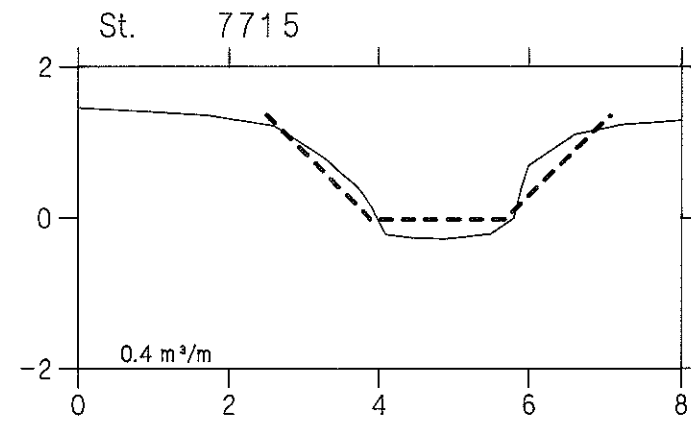
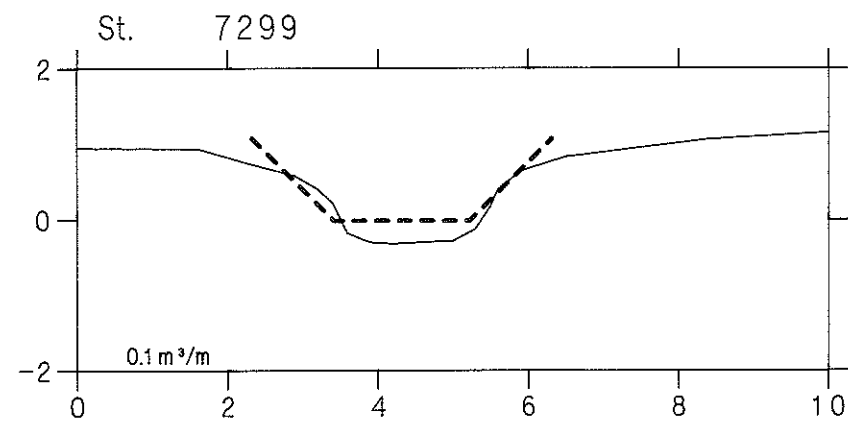
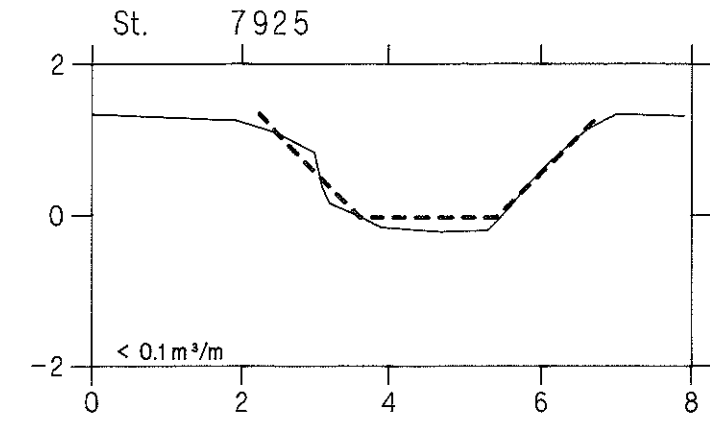
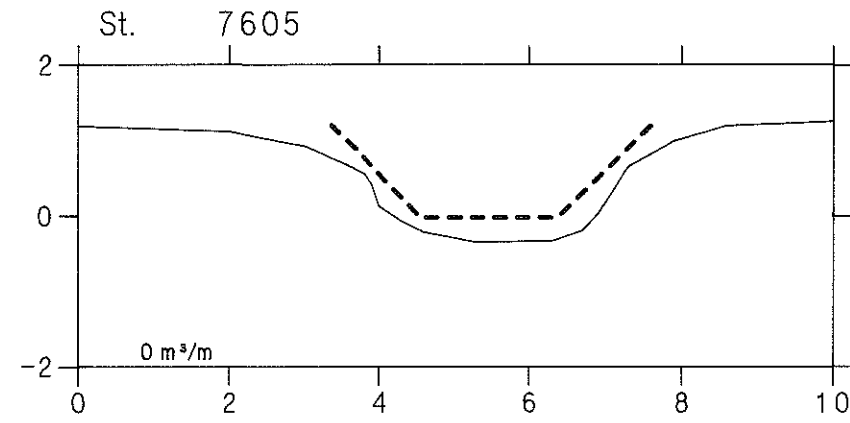
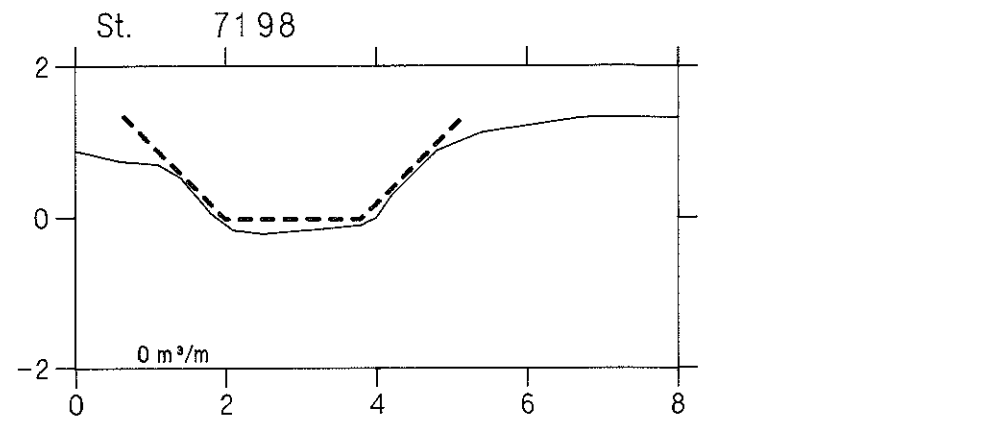

TJÆREBY-BASNÆS RENDEN

VASP 

HEDESELSKABET 

— Opmåling af DDH/Roskilde feb. 1995

- - - - - Nyt regulativ

lodret akse : kote i m skala 1:100
vandret akse : afstand i m skala 1:100

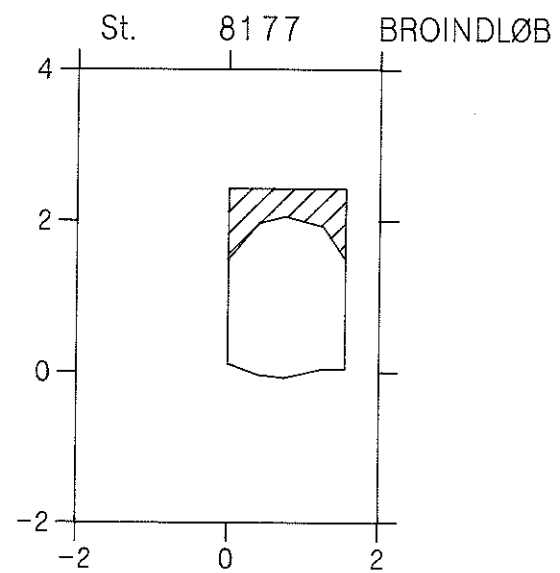
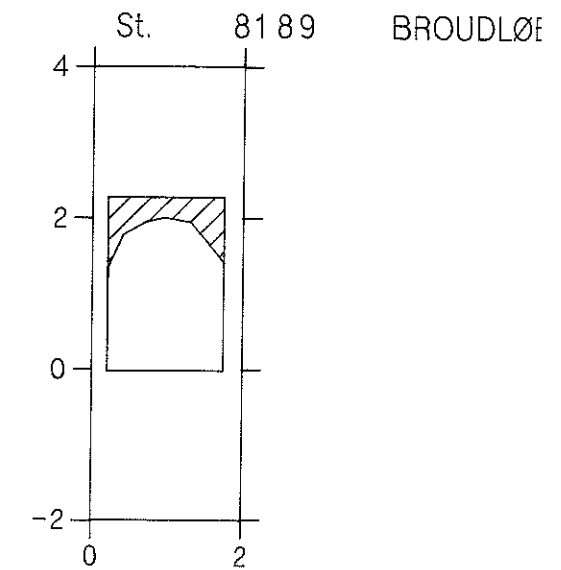
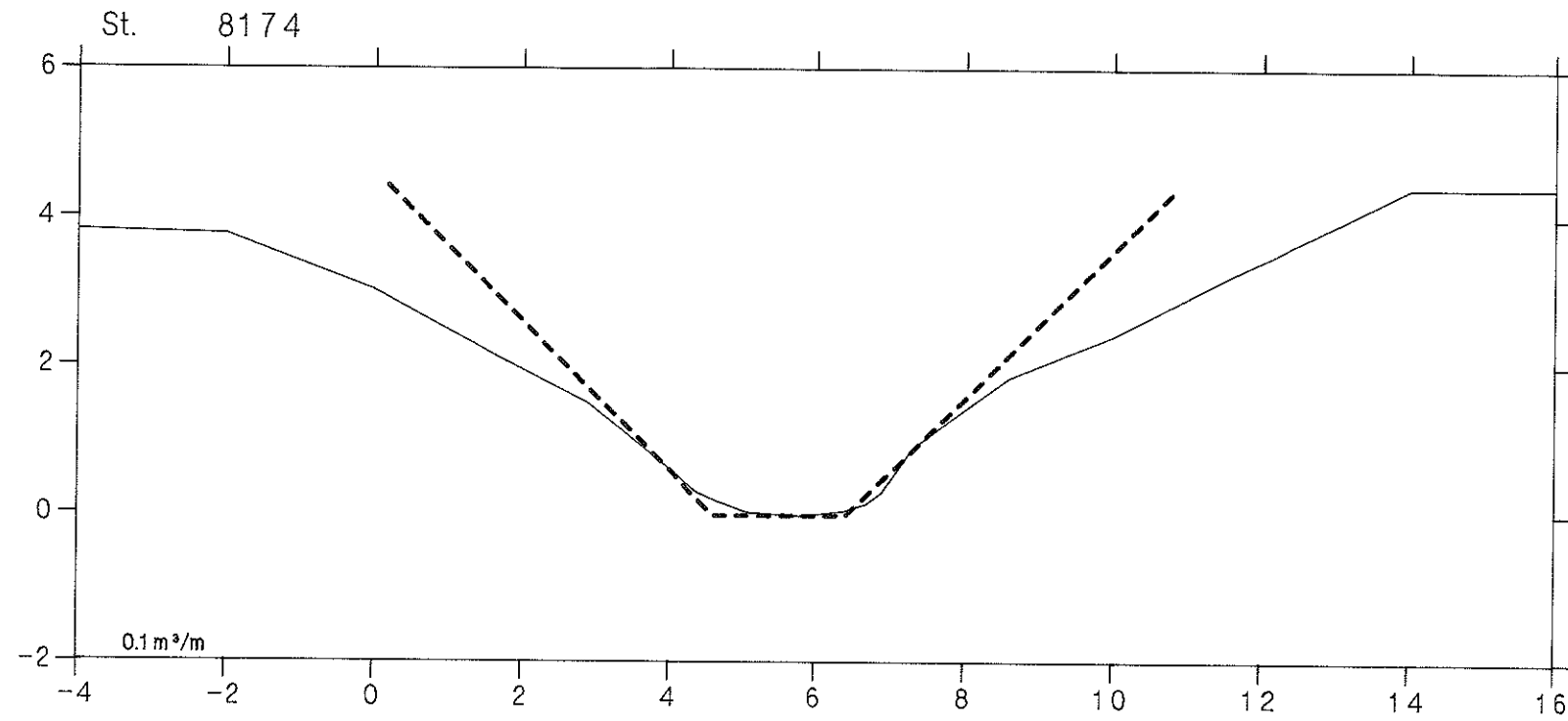
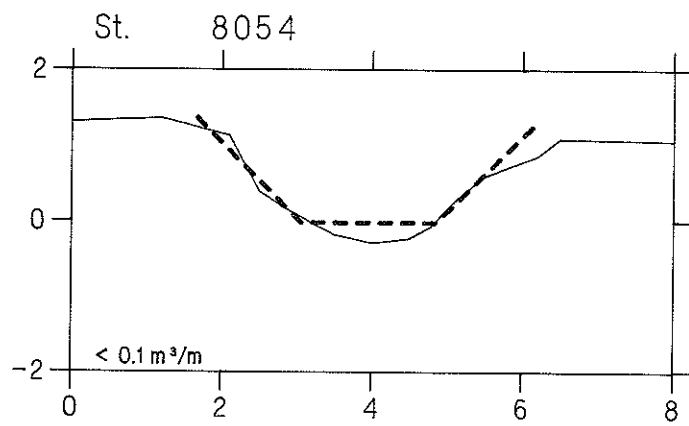
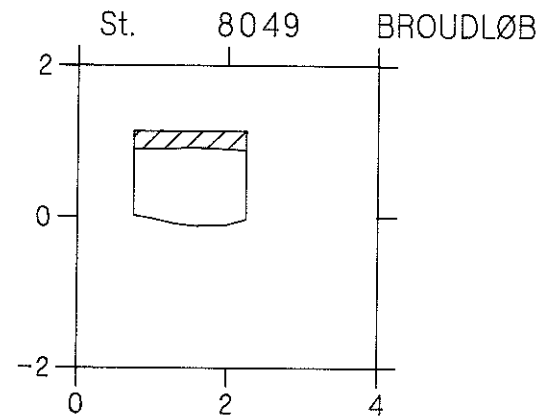

TJÆREBY-BASNÆS RENDEN

VASP 

HEDESELSKABET



— Opmåling af DDH/Roskilde feb. 1995

- - - - - Nyt regulativ

lodret akse : kote i m skala 1:100

vandret akse : afstand i m skala 1:100

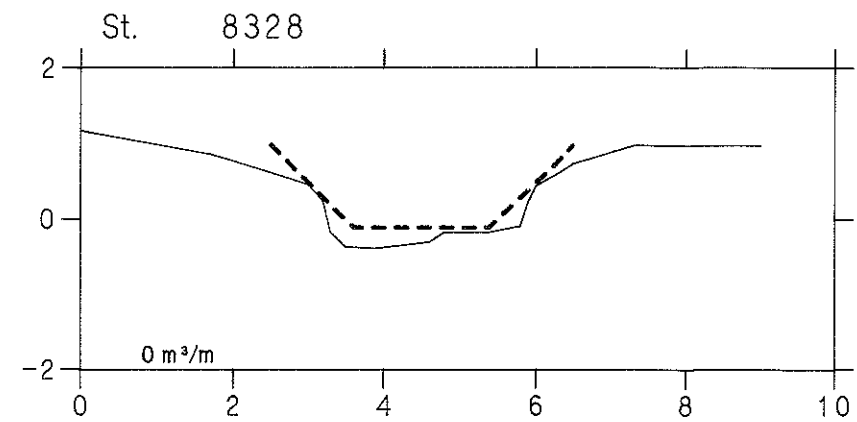
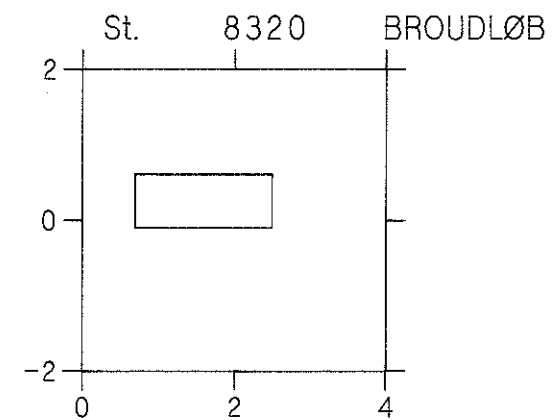
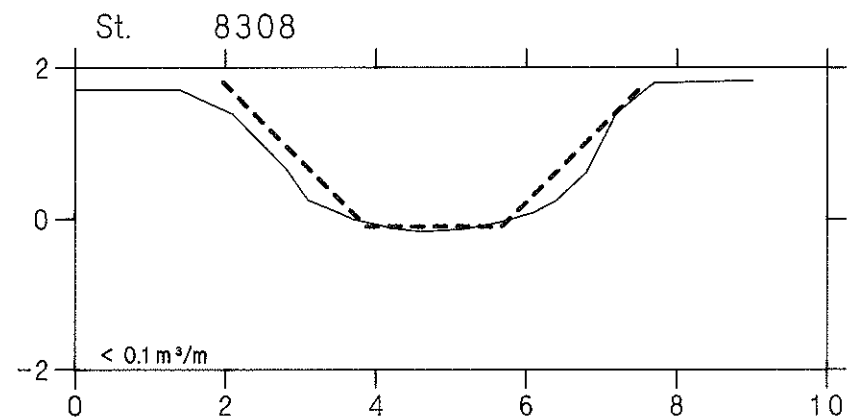
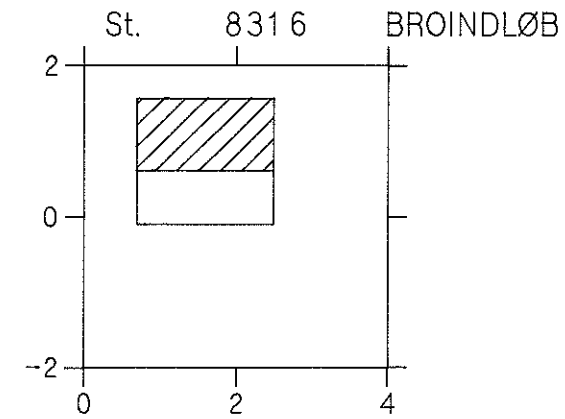
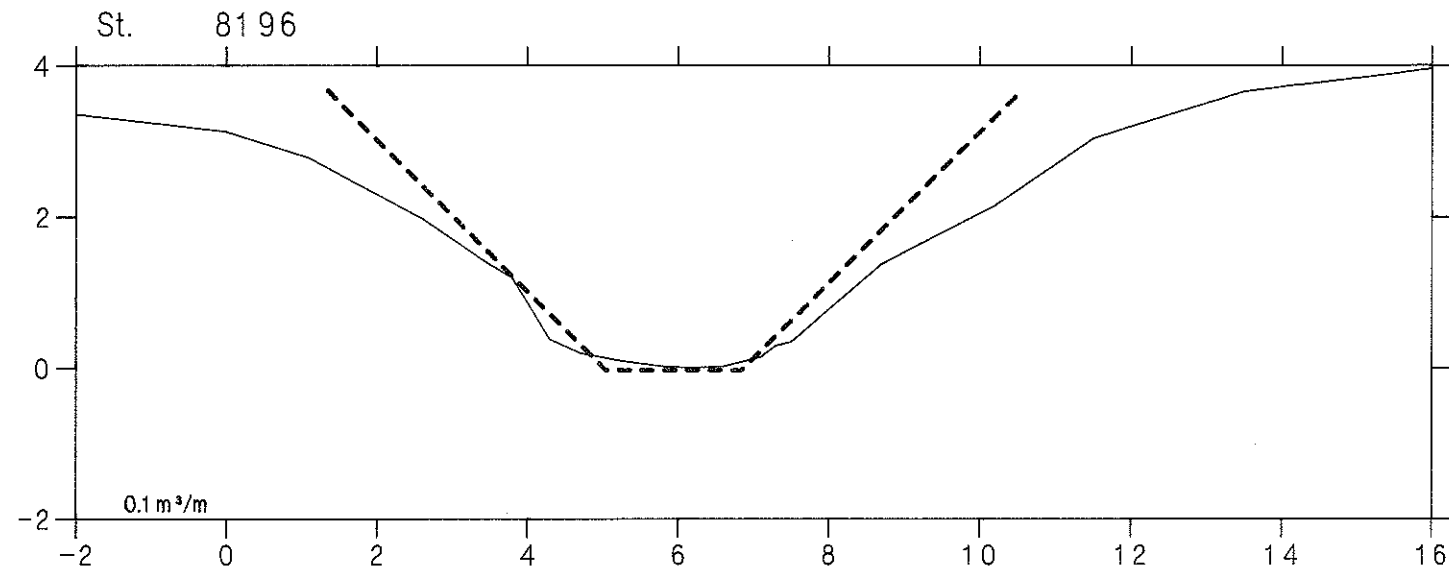

TJÆREBY-BASNÆS RENDEN

VASP 

— Opmåling af DDH/Roskilde feb. 1995

- - - - - Nyt regulativ

lodret akse : kote i m skala 1:100

vandret akse : afstand i m skala 1:100

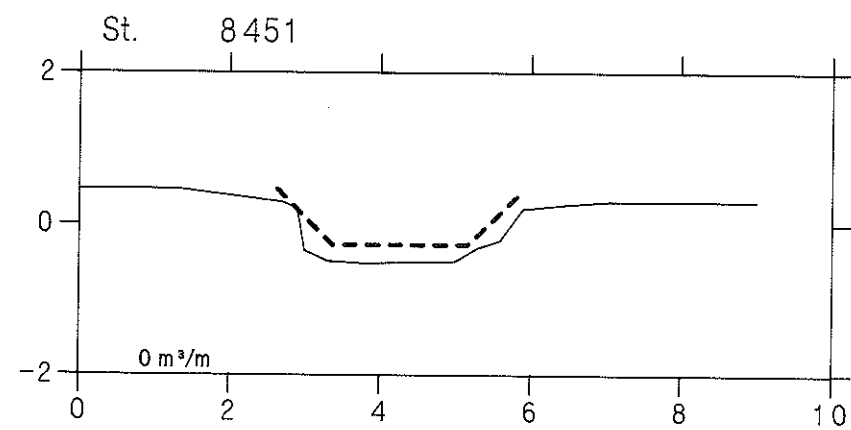

HEDESELSKABET

