

LUNGRENDEN

VASP 

HEDESELSKABET 

— Opmåling foretaget af DDH/Roskilde marts 1994

- - - - - Nyt regulativ

lodret akse : kote i m skala 1:100

vandret akse : afstand i m skala 1:100

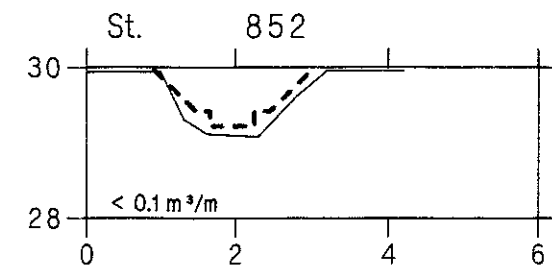
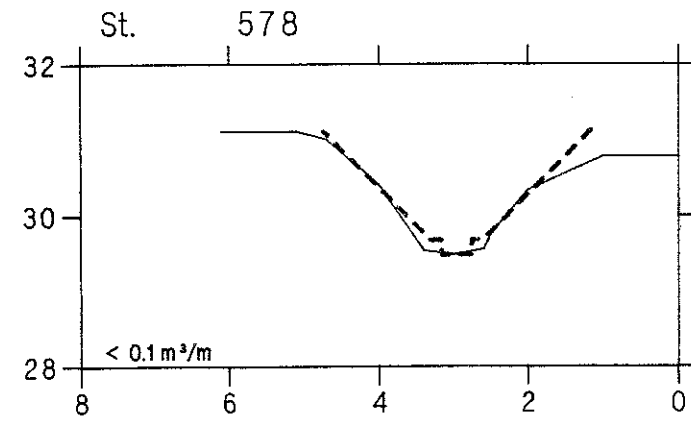
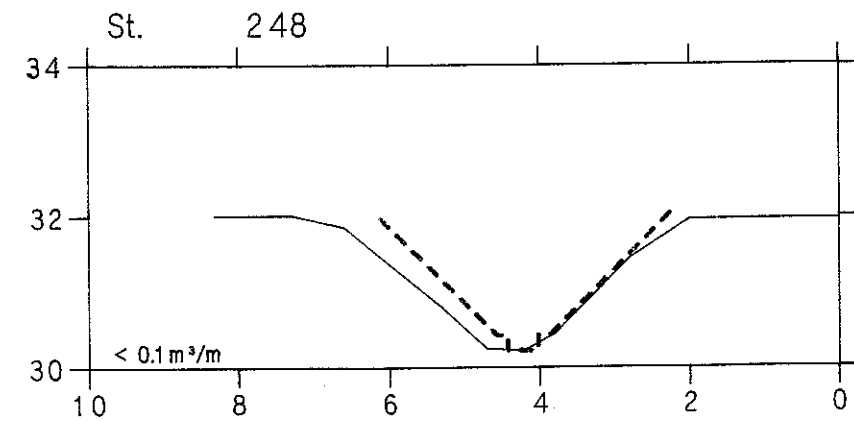
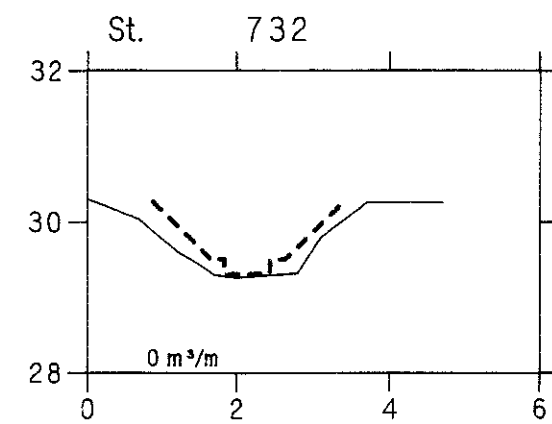
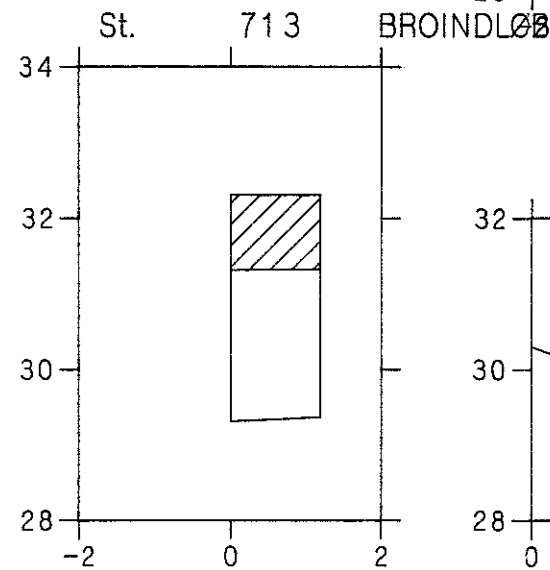
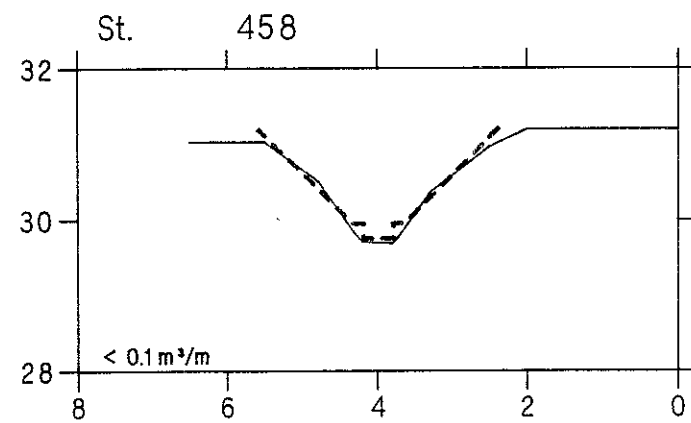
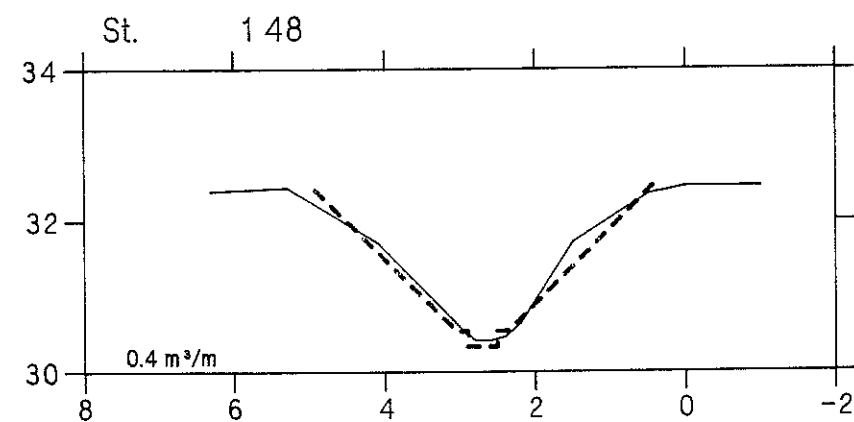
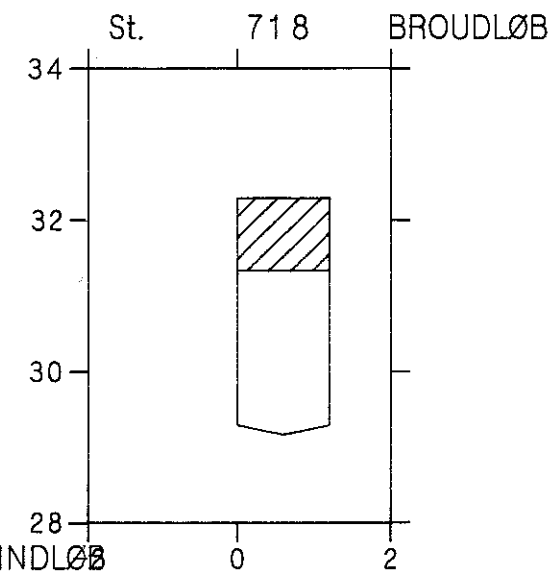
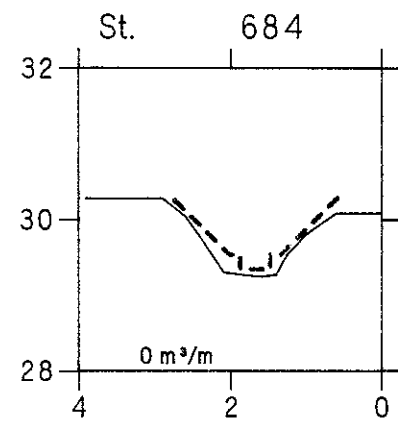
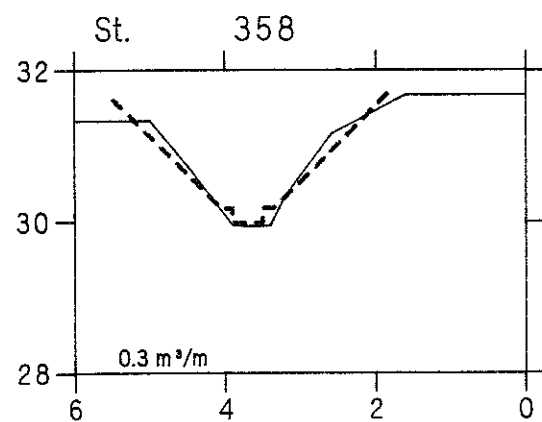
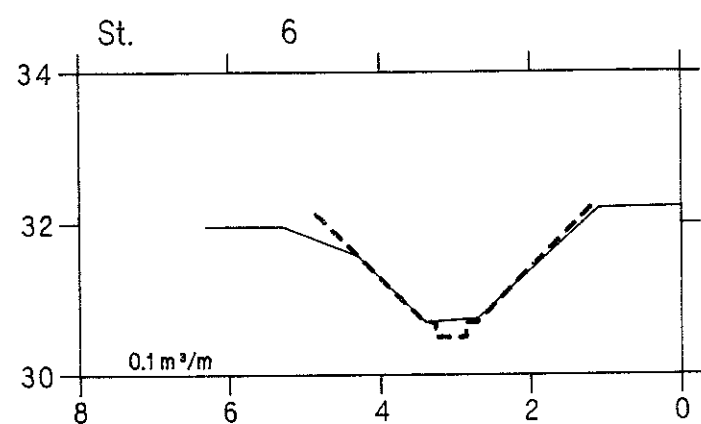

LUNGRENDEN

VASP 

HEDESELSKABET 

— Opmåling foretaget af DDH/Roskilde marts 1994
- - - - - Nyt regulativ

lodret akse : kote i m skala 1:100
vandret akse : afstand i m skala 1:100

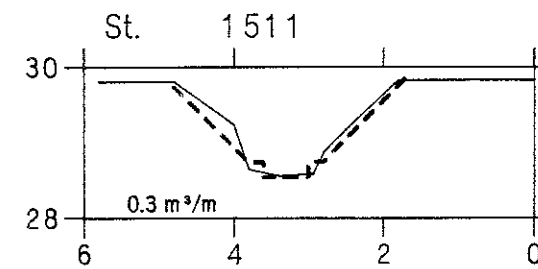
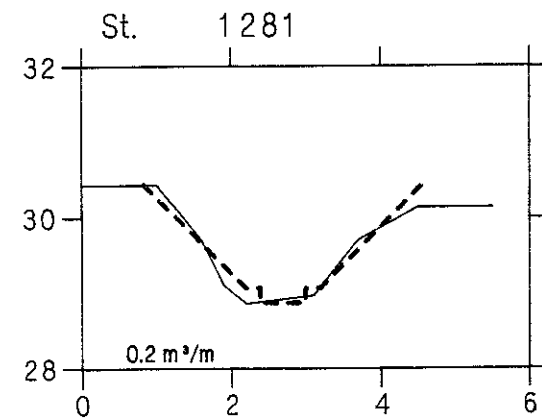
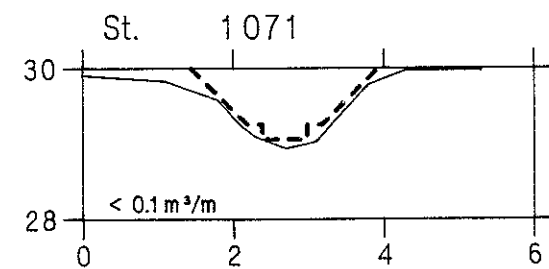
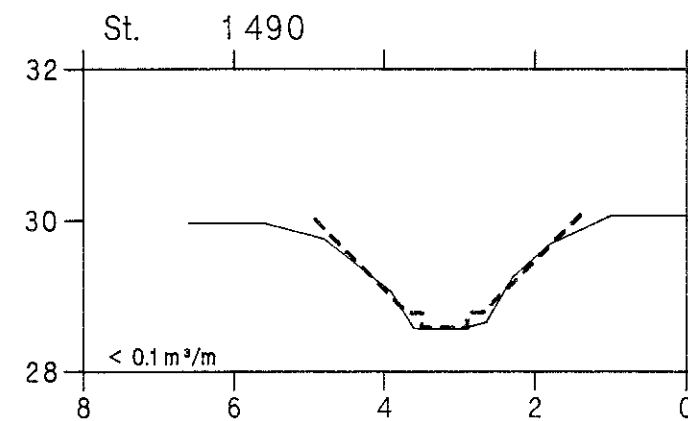
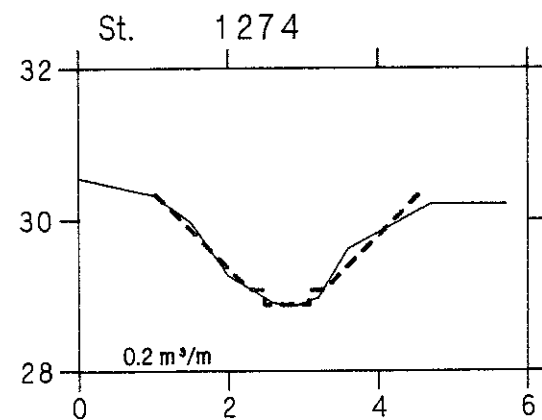
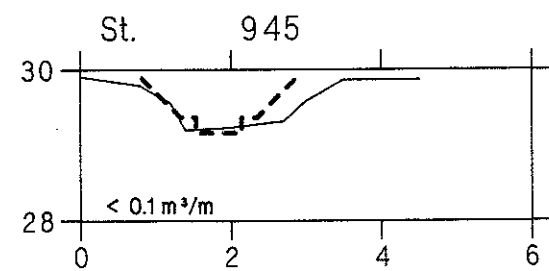
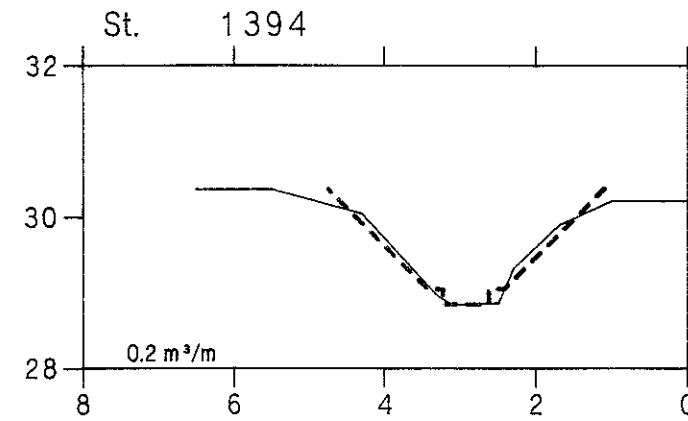
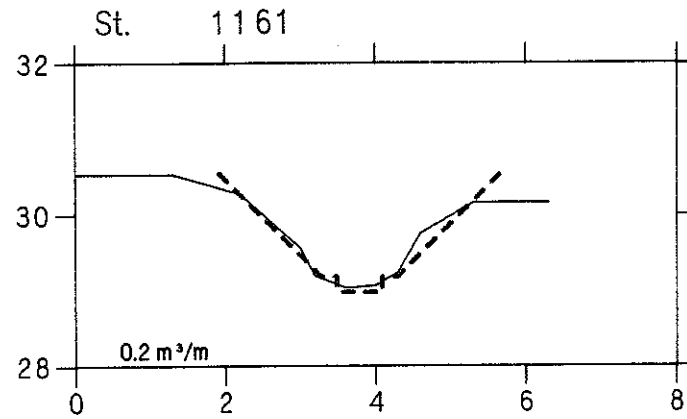
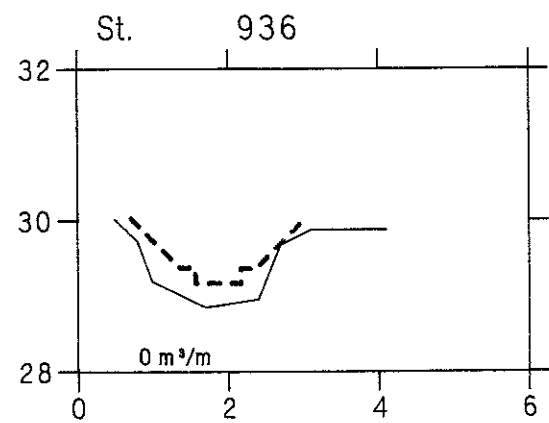

LUNGRENDEN

VASP 

HEDESELSKABET 

— Opmåling foretaget af DDH/Roskilde marts 1994

- - - - - Nyt regulativ

lodret akse : kote i m skala 1:100
 vandret akse : afstand i m skala 1:100

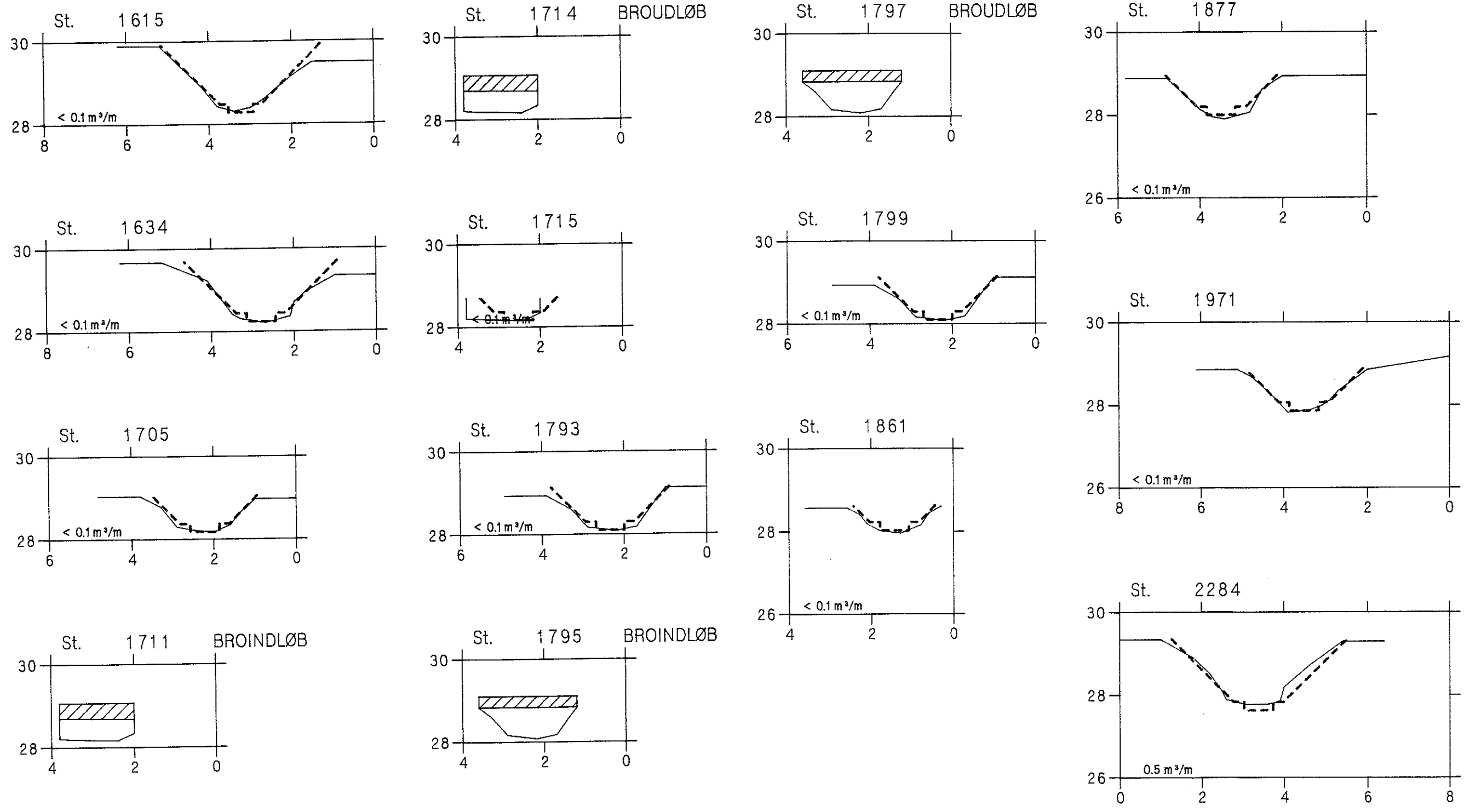

LUNGRENDEN

VASP 

— Opmåling foretaget af DDH/Roskilde marts 1994

- - - - - Nyt regulativ

lodret akse : kote i m skala 1:100

vandret akse : afstand i m skala 1:100

HEDESELSKABET

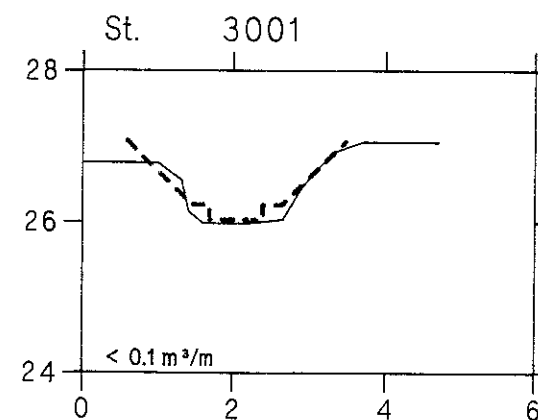
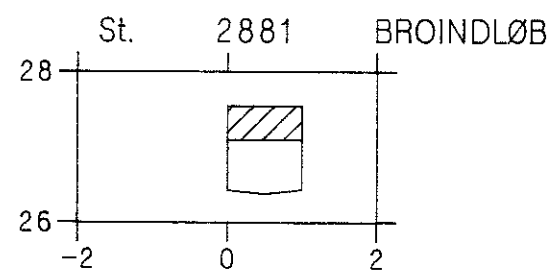
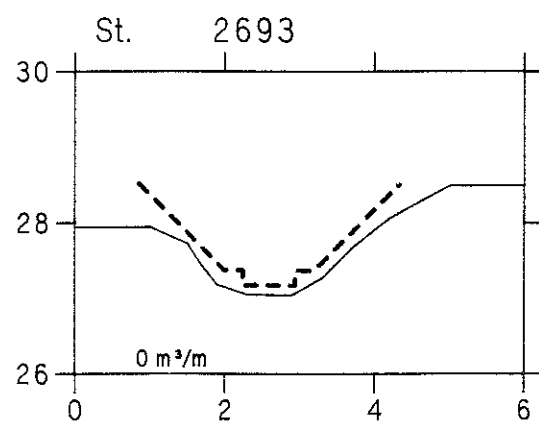
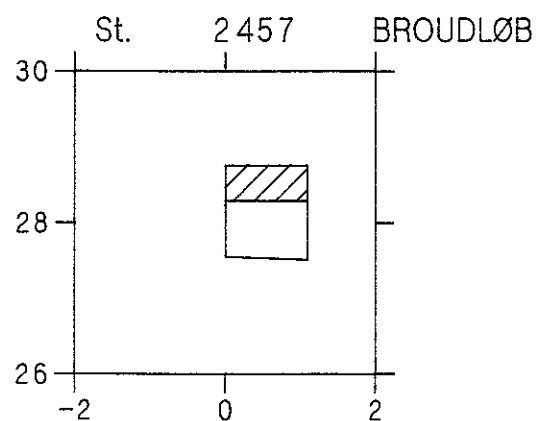
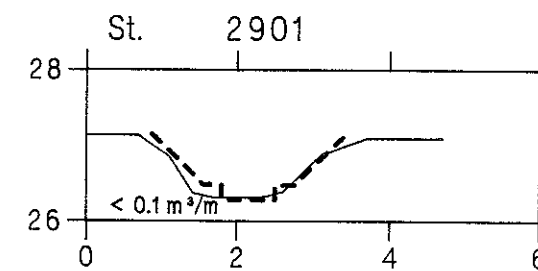
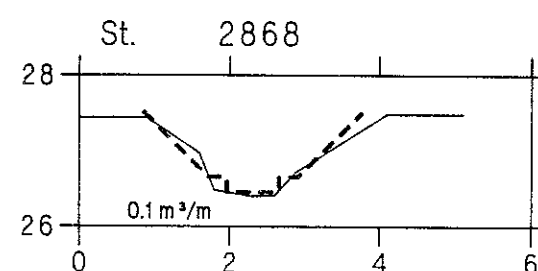
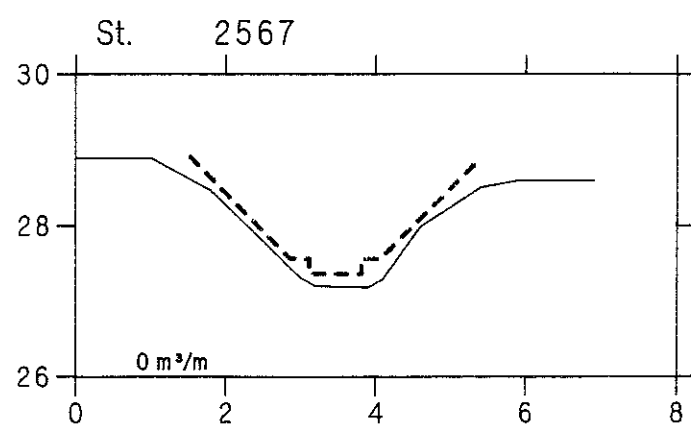
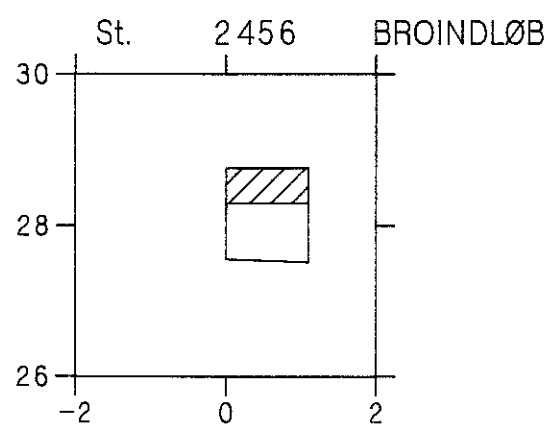
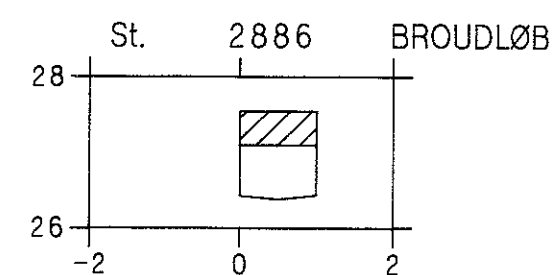
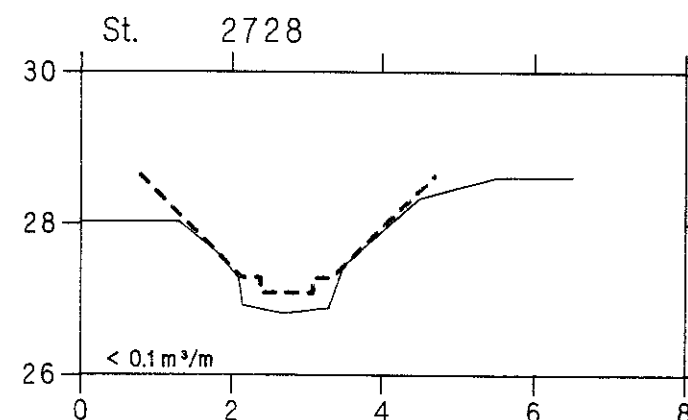
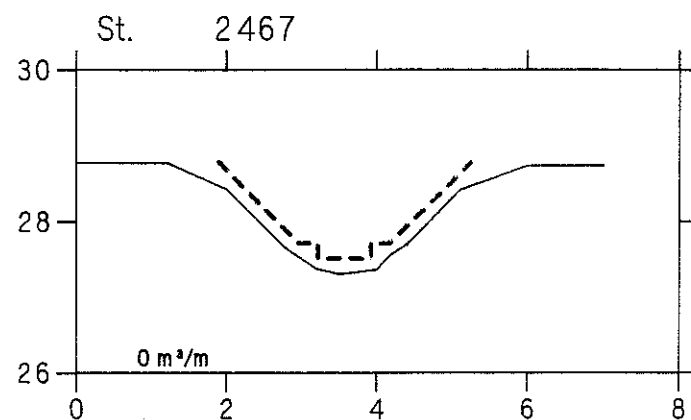
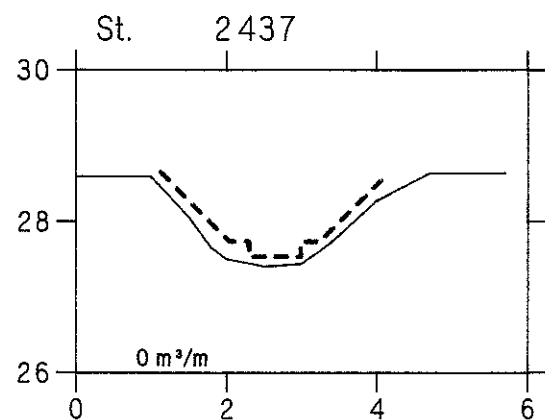

LUNGRENDEN

VASP 

HEDESELSKABET 

— Opmåling foretaget af DDH/Roskilde marts 1994

- - - - - Nyt regulativ

lodret akse : kote i m skala 1:100
vandret akse : afstand i m skala 1:100

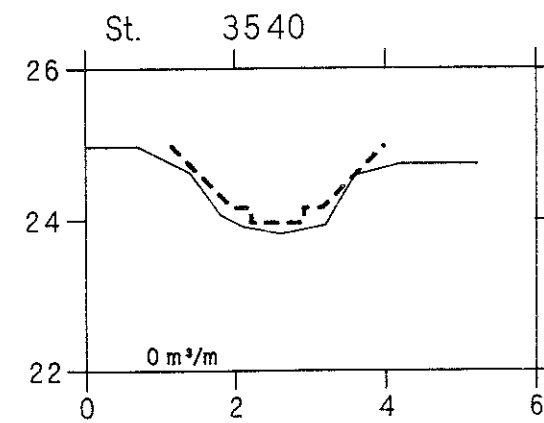
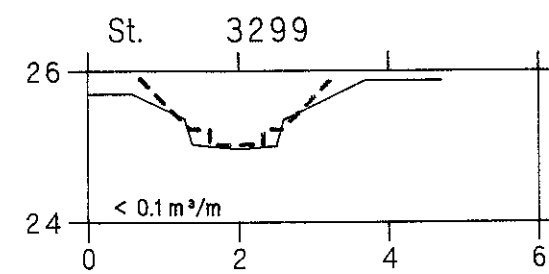
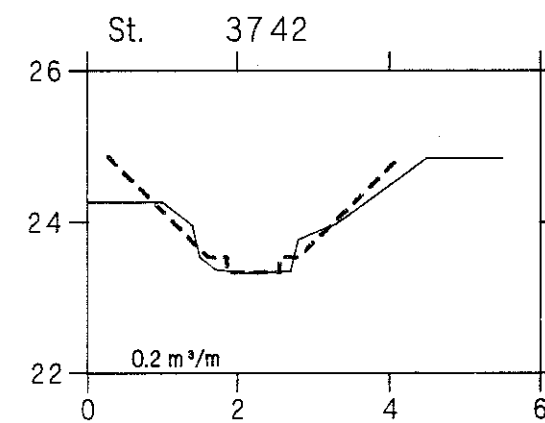
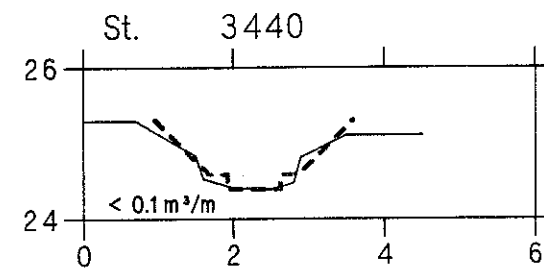
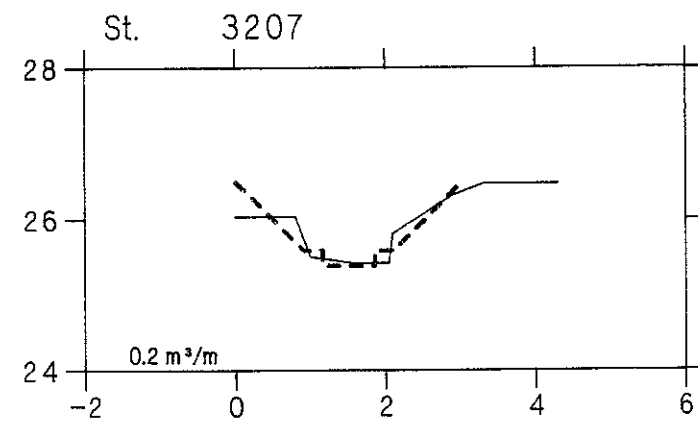
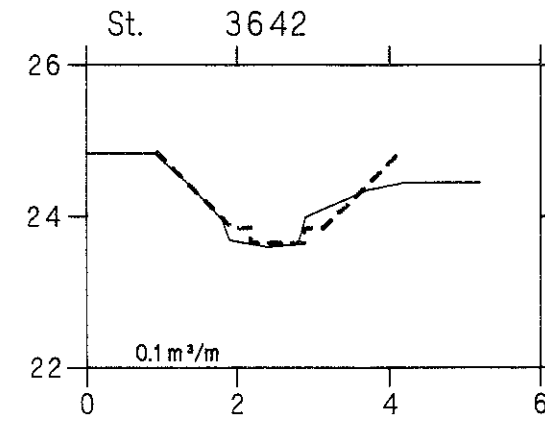
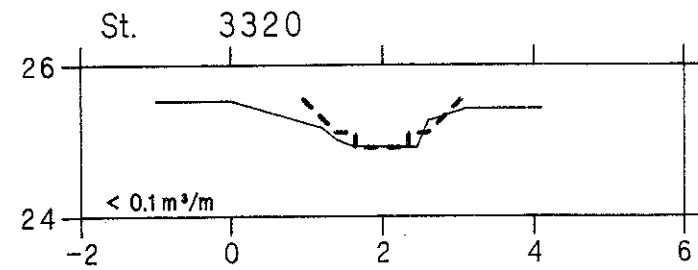
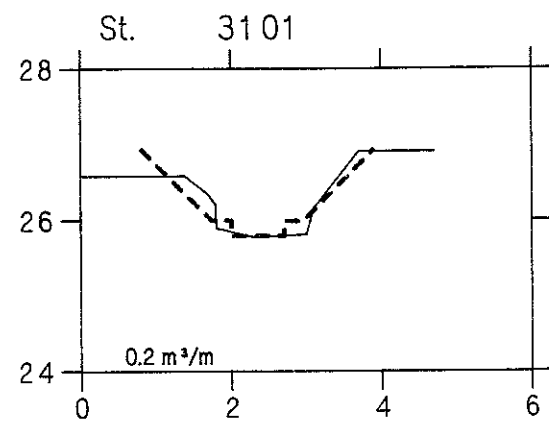

LUNGRENDEN

VASP 

HEDESELSKABET 

— Opmåling foretaget af DDH/Roskilde marts 1994

- - - - - Nyt regulativ

lodret akse : kote i m skala 1:100
vandret akse : afstand i m skala 1:100

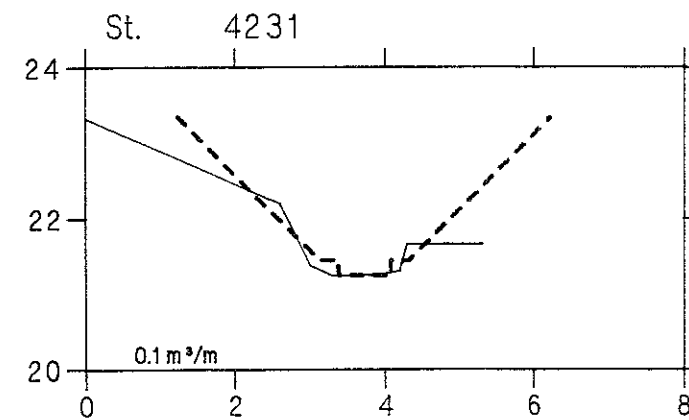
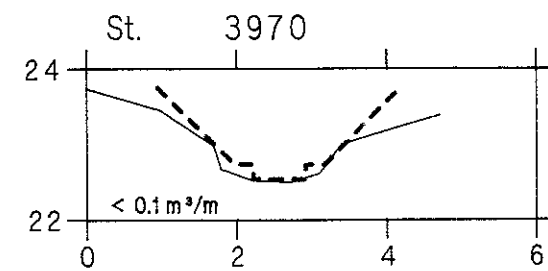
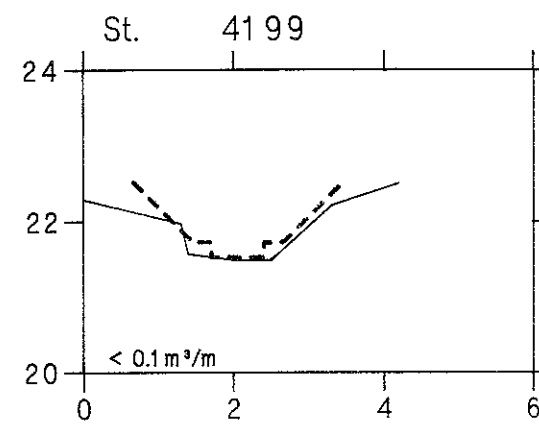
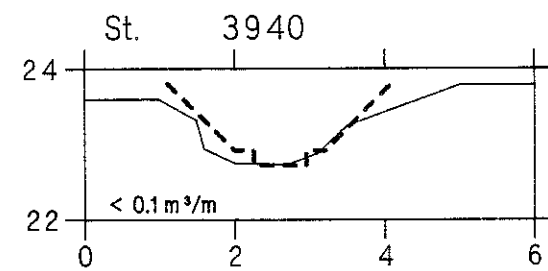
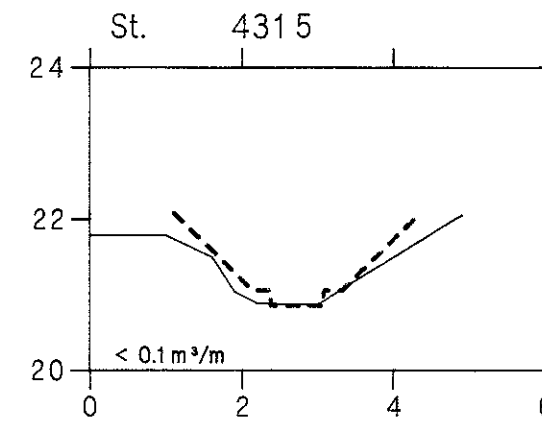
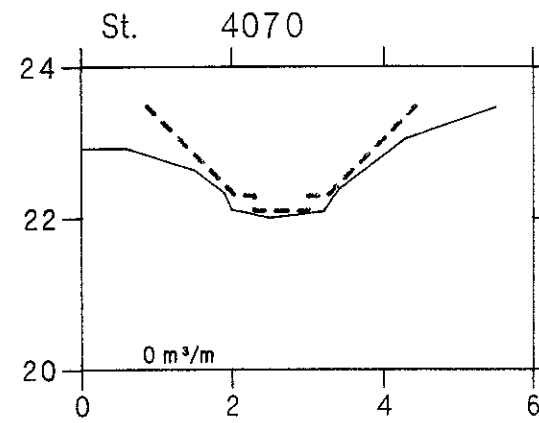
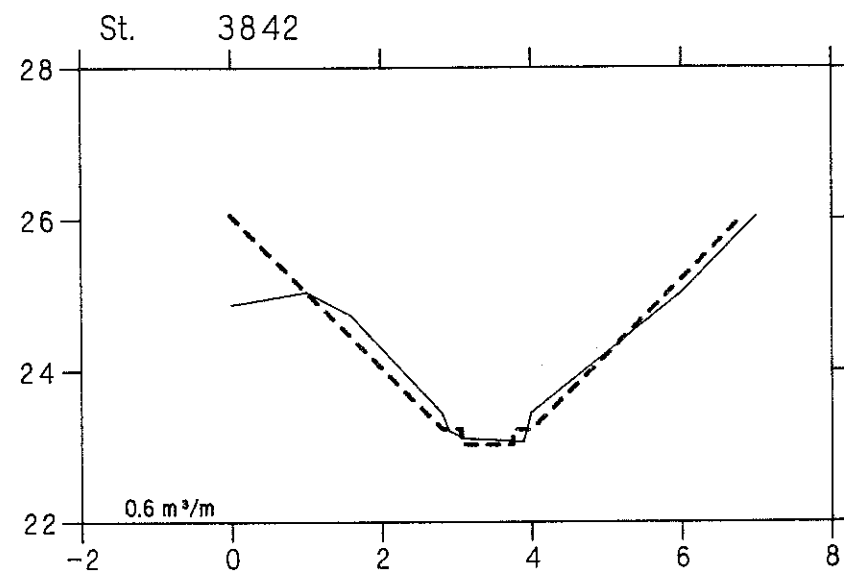

SIDELØB NR. 8ba (LUNGRENDEN)

VASP 

HEDESELSKABET 

— Opmålt af DDH/Roskilde marts 1994

- - - - - Nyt regulativ

lodret akse : kote i m skala 1:100

vandret akse : afstand i m skala 1:100

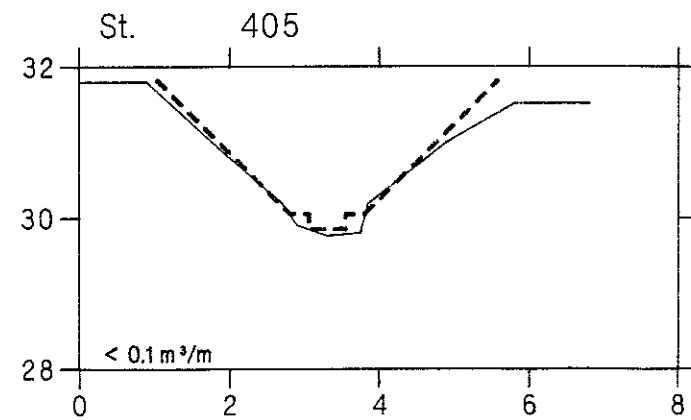
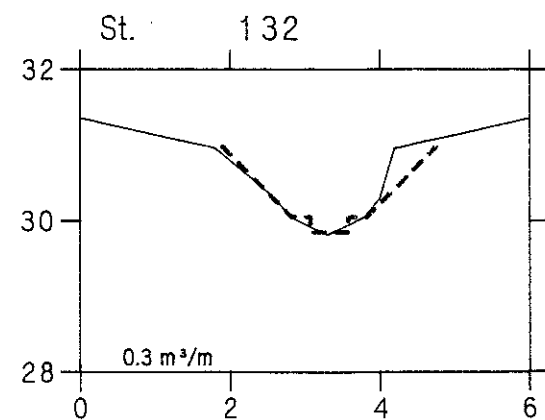
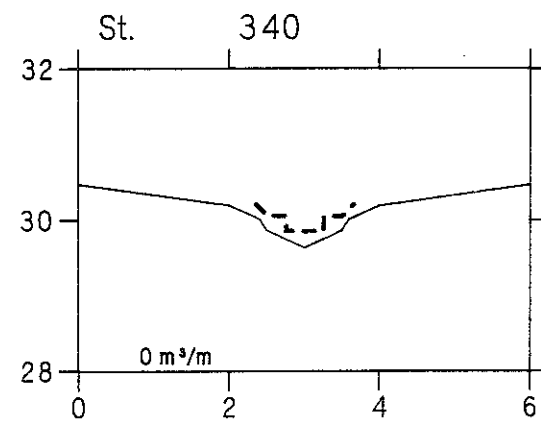
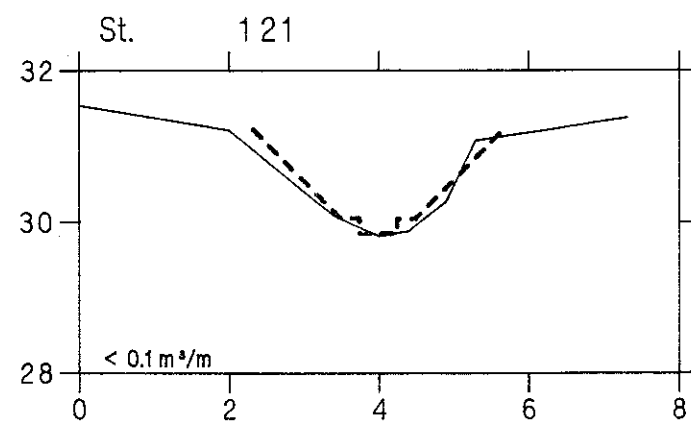
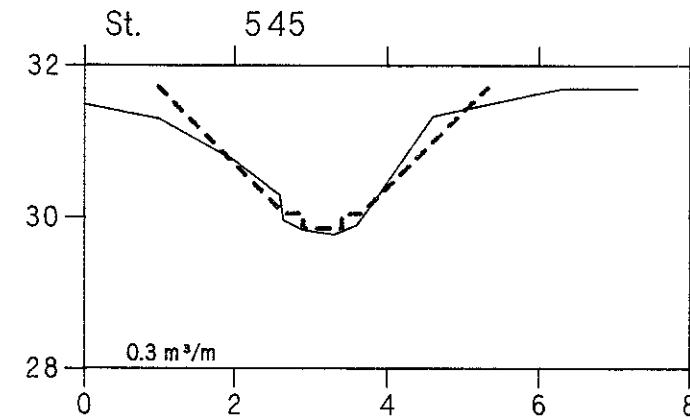
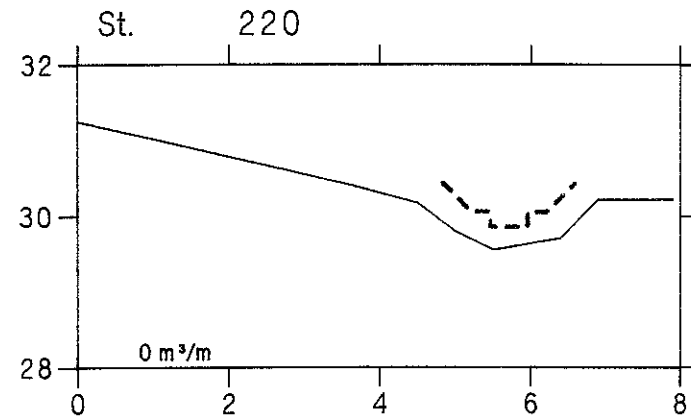
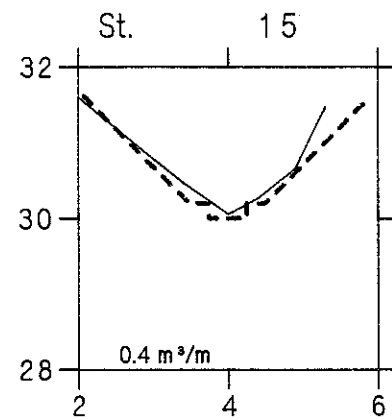

SIDELØB NR. 8ba I (LUNGRENDEN)

VASP 

HEDESELSKABET 

— Opmålt af DDH marts 1994

- - - - - Nyt regulativ

lodret akse : kote i m skala 1:100
vandret akse : afstand i m skala 1:100

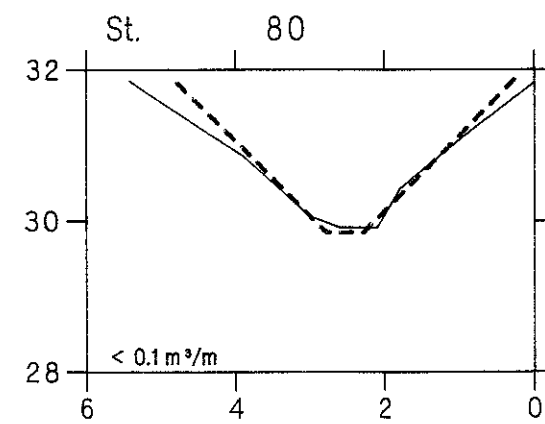
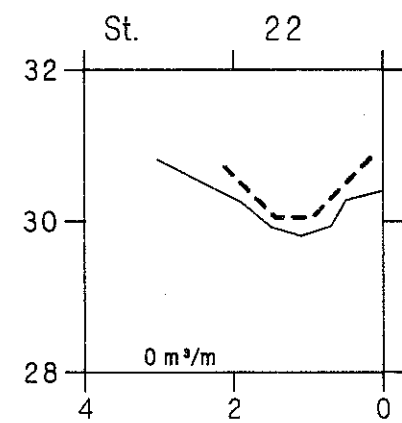
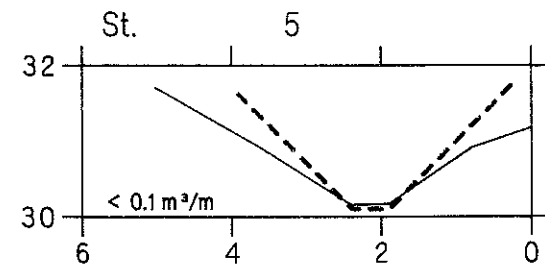

SIDELØB NR. 8ba III (LUNGRENDEN)

VASP 

— Opmålt af DDH/Roskilde marts 1994
- - - - - Nyt regulativ

lodret akse : kote i m skala 1:100
vandret akse : afstand i m skala 1:100

HEDESELSKABET 

